



***PORTS***



***PARKS***

# **Dura Trench**

manufactured by Eric'sons

**THE VERSATILE TRENCH SYSTEM**



***INDUSTRIAL***



***HIGHWAYS***

[www.trenchdrain.net](http://www.trenchdrain.net)

# TABLE OF CONTENTS

3	INTRODUCTION
4-5	SPECIFICATION GUIDE
6-7	FLOW CAPACITIES
8-15	PREFABRICATED TRENCH DRAINS (DTPF)
16-23	SLOTTED PIPE (DTSP)
24-25	TRUE RADIUS TRENCH DRAINS (DTRPF)
26-27	TRUE RADIUS SLOT PIPE (DTRSP)
28-33	STAINLESS STEEL TRENCH DRAINS (DTSS)
34-35	CHEMICAL RESISTANT TRENCH DRAINS (DTCF)
36-37	MEMBRANE & SHOWER DRAINS (DTSH)
38-43	TRENCH FORMING SYSTEMS (DTTF)
44-49	UTILITY TRENCHES (DTUTPF)
50	CATCH BASINS & SUMPS (DTCBPF)
51	FRAMES
52	TRASH & DEBRIS STRAINERS
52	TURNS & INTERSECTIONS
52	GRATE LOCKS
53	OUTLET CONNECTIONS
53	JOINT SEALANT
54-69	GRATES





# INTRODUCTION

Eric'sons was founded in 1998 with a mission of providing quality products to meet a variety of project needs. Eric'sons offers design, manufacturing, sales, installation, and repair of linear drain products. The company founders were engineers and entrepreneurs who created products that were both innovative and simple.

Eric'sons spent years developing the Dura-Trench brand of linear drainage systems. Innovation was spawned from the construction division of the company while assisting engineers with designs and installing other manufacturers products. Eric'sons set out to improve linear drain systems to make them more flexible for the designer, easier for the installer, and higher quality for the owner. Eric'sons staff began the innovative process of redesigning the linear drain system.

Eric'sons continues to grow and offer the same services it started with over a decade earlier. These services include design, manufacturing, sales, installation, and repair of linear drainage products. The Dura-Trench product line features a full offering of trench drains, slotted drains, utility trenches, catch basins, and many specialty products. The flexibility of the product line and wide breadth of standard products gives us the flexibility to handle most drainage problems. We encourage you to challenge our team with your most difficult drainage applications.



**TEAMWORK, INNOVATION, AND CONTINUOUS IMPROVEMENT DEFINE OUR TEAM**

# SPECIFICATION GUIDE

To properly specify a linear drain it is necessary to understand all of the components that make up a complete system. If the designer fails to properly specify each of the system components, failures can occur at the weakest link.

The designer must consider three major design parameters. The first is the loading condition. The designer should follow the load path through the components of a linear drain system. Loads are imposed on linear drains from the top down. The load first enters the grating. Assuming the grate was properly specified the load is then transferred from the grate to the frame. Assuming the frame is sufficiently strong and anchored properly in the concrete surround, the load is then passed to either the trench body or concrete surround. Dura-Trench systems are generally designed to pass all loading from the frame directly to the concrete surround eliminating the potential for channel failure. Unfortunately, many other systems on the market pass the load through the trench body before it can reach the concrete and then the trench body strength must be evaluated. Dura-Trench bodies do not receive the load and act solely as a concrete form, smooth flow profile, and chemical resistant liner. The designer must take the responsibility to properly specify and evaluate the load carrying capacity of each of these components (grates, frames, body, and concrete surround). If any of these components fail the entire system will prematurely fail.

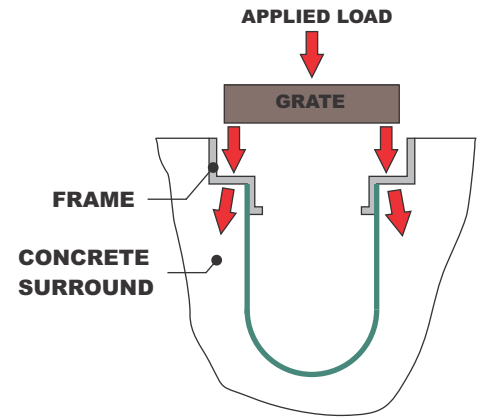

The second design parameter that must be evaluated is the flow path. The path of the liquid flowing must be adequately sized at all points along the system. The liquid first passes through the grate. If the openings in the grate are sufficient the liquid will reach the channel. If the channel has adequate size and slope to move the liquids, it will convey down the system to the outlet location. Finally, if the outlet is properly configured and sized then the liquid will exit the system. If any of these components are not properly sized the system will not function. Take care to evaluate each component before proceeding with a final design.

The final design parameters are the longevity and environment that the drain will be utilized. Things like material degradation due to the environment the drain is placed in must be carefully considered. For example, if the liquids are at elevated temperatures or have chemical loads special consideration should be given to material choices that can resist the chemical loads and elevated temperatures. This should also raise concern about how the trench bodies are sealed. Considerations should also be given to aesthetic concerns (colors & finishes), traffic type (ADA, Heel proof), grating patterns, abutting materials, etc.

After the correct product has been determined a proper written specification needs to be generated to ensure that the contractor provides a product that meets all the requirements of the design. The product specification should specify each component including the trench body, slope, grate, frame, grate lock, outlet, and joint sealant.



**NOTE:** The majority of linear drain specifications are incomplete or incorrect. This leads to confusion, added project costs, and premature failures of linear drainage systems.





Dura-Trench is a versatile system with a large selection of interchangeable components that can be utilized for a wide range of applications. This specification guide will assist you in writing an accurate specification that meets a specific application.

Product selection and application is achieved through a series of seven specification slots in which the specifier can select the trench body material, slope, grate, frame, grate locking device, outlet, and joint sealant. When all designations in the specification are properly filled in, the designer can ensure that the correct product is specified for a particular application.



**SAMPLE SPECIFICATION:**

DTPF-1%-05B24DI-HDBP-GLSS-6B-SLUR  
 slots    1    2    3    4    5    6    7

**SLOT 1 - TRENCH BODY**

- DTPF = Prefabricated GFRPC body (Polyester resin)
- DTCF = Prefabricated GFRPC body (Chemical resistant Vinyl Ester)
- DTFR = Prefabricated Fire Retardant GFRPC body
- DTSS = Stainless steel trench body (304 typ, 316 is available)
- DTTF = Forming system (body is removed for a concrete cast in place trench)
- DTRPF = True radius precast GFRPC body (Polyester resin)
- DTSP = Prefabricated fiber reinforced slot drain body (grating selected for this option only refers to clean-outs)
- DTGP = Galvanized steel slotted pipe (grating selected for this option only refers to clean-outs)
- DTUTPF = Prefabricated utility trench with standard GFRPC body (polyester resin)
- DTUTCF = Prefabricated utility trench with chemical resistant GFRPC body (Vinyl Ester)
- DTUTFR = Prefabricated utility trench with fire retardant GFRPC body
- DTSH = Stainless steel trench body with flashing collar for membrane applications (T304 typ, 316 is available)

**SLOT 2 - SLOPE**

Typical slopes are 0.5% and 1.0%. If this slot is left blank, the inverts shown on the plans will be utilized (note that any slope can be specified using this method). If nothing is shown on the plans typically a 0.5% slope will be utilized.

**SLOT 3 - GRATE**

Utilize the part numbers of the desired grate in this slot. Grate part numbers can be found at the back of this literature. Note that when you select a grate it will by default determine the size of the trench. Example: If a 12" wide grate is selected, a 10" wide trench body will be paired with the grate for a complete system.

**SLOT 4 - FRAME**

- |  |   |
|--|---|
| LDTP - Light duty thermal plastic frame      | MDAL - Medium duty aluminum frame                         |
| MDGS - Medium duty galvanized steel frame    | MDSS - Medium duty stainless steel frame                  |
| HDBP - Heavy duty black powder painted steel | EXBP - Extreme duty black powder painted frame            |
| HDGS - Heavy duty galvanized steel           | EXGS - Extreme duty galvanized steel frame                |
| HDSS - Heavy duty stainless steel            | EXDI - Extreme duty ductile iron frame                    |
| HDFG - Heavy duty fiberglass frame           | NOTE: for slot drain frames add SP in middle (EX: MDSPAL) |

**SLOT 5 - GRATE LOCKING**

- |                                    |   |
|------------------------------------|---|
| GLNR - Grate locks not required    | GLVP - Vandal resistant grate locks                       |
| GLZN - Steel grate locks           | GL4B - Four corner bolt down of grates (where applicable) |
| GLSS - Stainless steel grate locks | GLWCB - Welded and threaded cross bar                     |

**SLOT 6 - OUTLET**

List pipe size (1" through 24") then location (S=side, B=bottom, E=end)

**SLOT 7 - JOINT SEALANT**

- |                                |                                  |
|--------------------------------|----------------------------------|
| NSR - no sealant required      | SLCF - Vinyl Ester joint sealant |
| SLUR - urethane caulk          | SLWD - Weld joints water tight   |
| SLPF - Polyester joint sealant |                                  |



# TRENCH FLOW CHARACTERISTICS

These trench flow charts are supplied to assist the designer in selecting the appropriate size trench drain. In order to properly size a trench drain, the designer must take into account many different design considerations. Below are the factors that should be reviewed in making this determination.

1. Required flow volume is calculated to generate the proper width, depth, and slope that will work for the application.
2. Debris load should be reviewed. Note that larger trenches will be able to hold more debris, however, smaller trenches with greater slope may pass the debris better due to higher flow velocities creating scouring characteristics.
3. Sites with steep cross slopes may need wider trenches in order to catch high velocity flows sheeting toward them without allowing bypass flow.
4. Consider constructability when selecting a size. Note that a narrower trench that is slightly deeper will typically be less expensive to install than a larger trench that is shallower. This is typically true of trenches less than 36" deep.

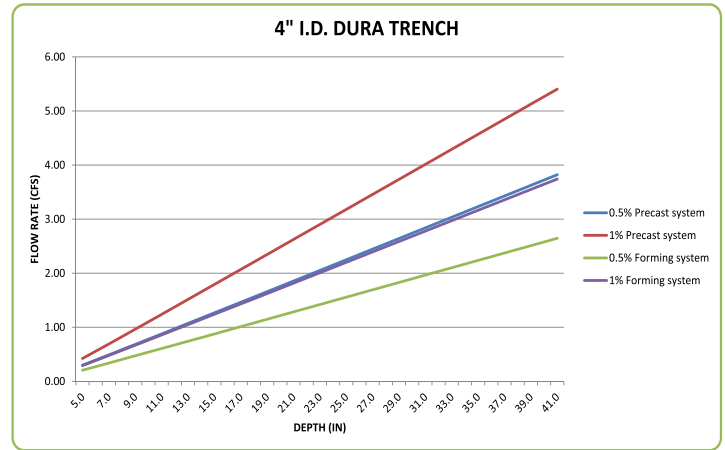
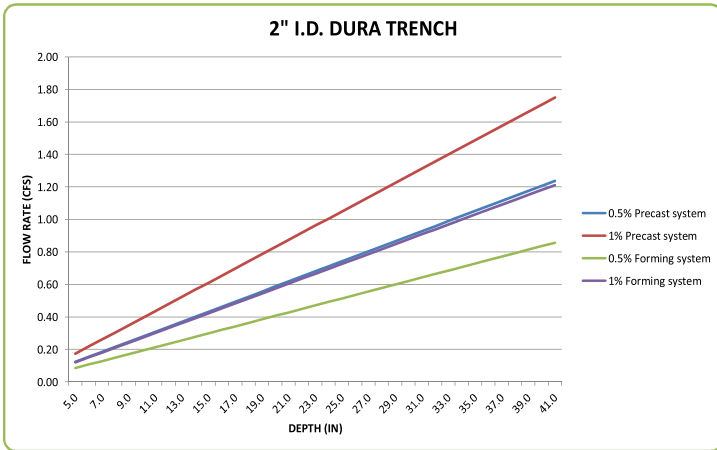

**DESIGNER TIP:** Verify that the outlet method is properly sized to carry the desired flow and debris loading. It is common for a trench to be properly sized but restricted by the outlet size or configuration. The outlet detail is equally as important as the size of the drain and can be a choke point in the flow. A system is only as good as its weakest link. Ensure the outlet configuration and size is not the limiting factor in the system design.

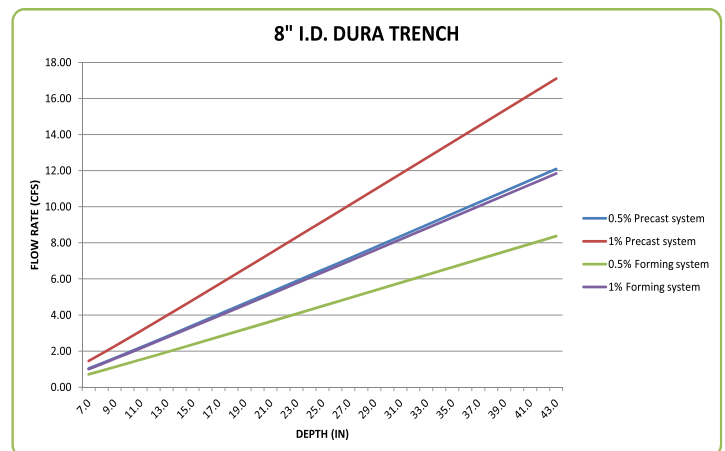
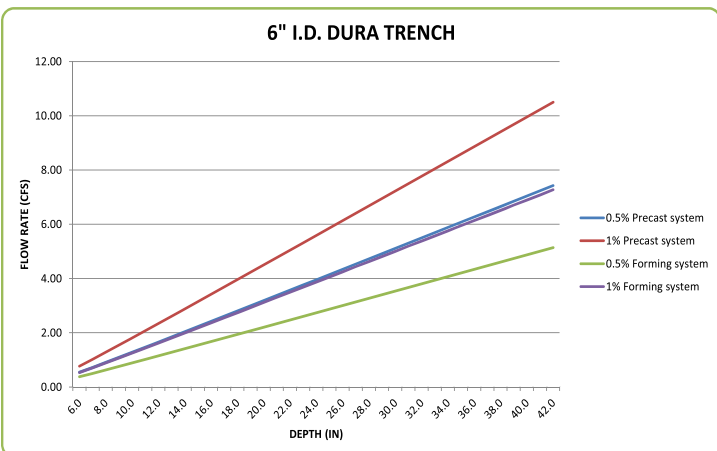



**10" I.D. DURA TRENCH**

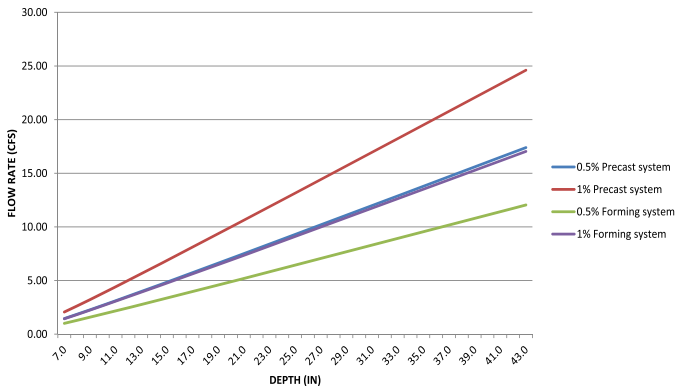

**12" I.D. DURA TRENCH**

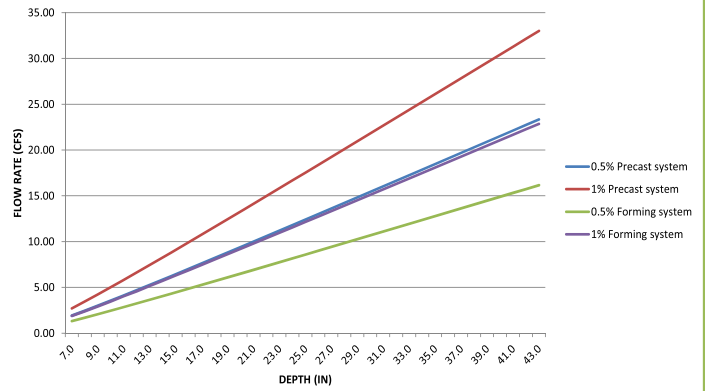

**18" I.D. DURA TRENCH**

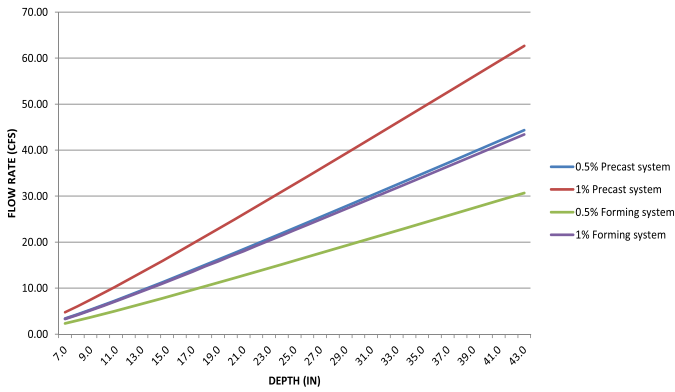

**24" I.D. DURA TRENCH**

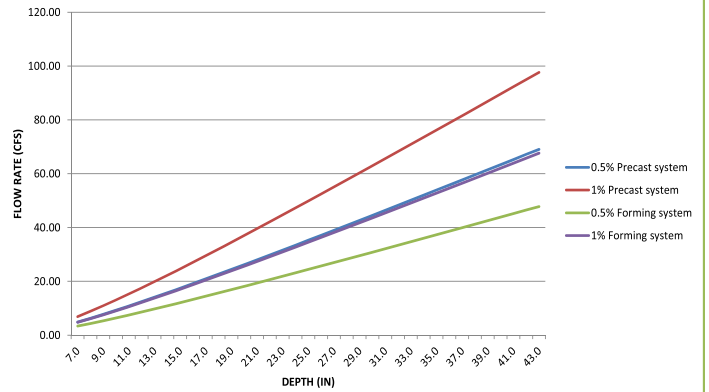

For questions about sizing a trench please contact our experienced technical support staff. We will be happy to assist you with calculations, CAD drawings, material selections, and layout drawings.

**36" I.D. DURA TRENCH**

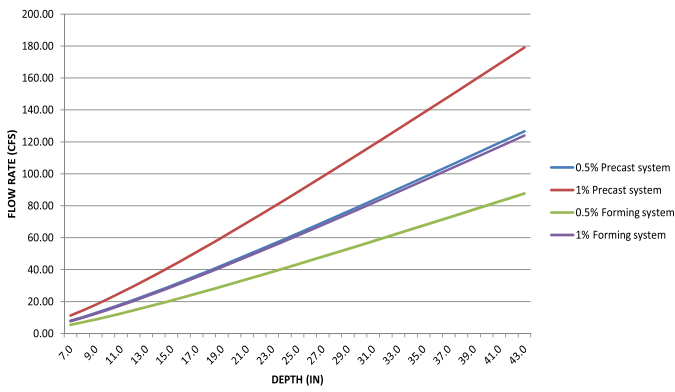

**48" I.D. DURA TRENCH**

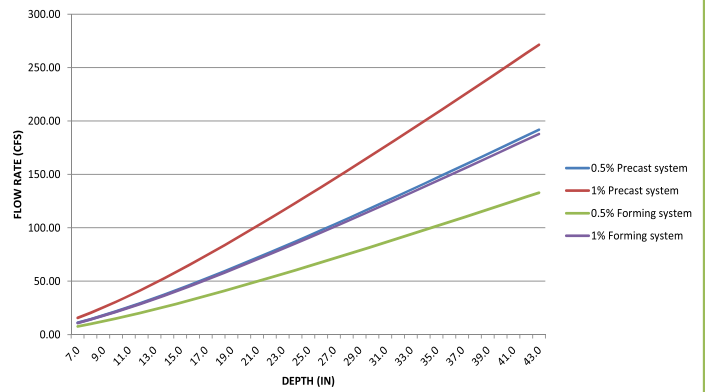

# PREFABRICATED TRENCH DRAINS (DTPF)

## STANDARD

### SIZES

2" ID

4" ID

6" ID

8" ID

10" ID

12" ID

18" ID

24" ID

36" ID

48" ID

## TRENCH BODY

- 8' LENGTHS TYPICAL
- OFFERED IN 10', 16', AND 20' LENGTHS
- WIDTHS FROM 2" - 48" STANDARD
- CUSTOM WIDTHS & PROFILES

## JOINTS

- LARGE 2" BELL CONNECTIONS
- WATERTIGHT SEAL ATTAINABLE WITH FACTORY SUPPLIED SEALANT



## PREFABRICATED TRENCHES

- FIBER REINFORCED POLYMER CONCRETE BODY  
INSTALLS FAST AND IMPROVES FLOW RATES
- RESISTANT TO DILUTE CHEMICALS, ROAD SALTS, AND  
PETROLEUM PRODUCTS
- PLYWOOD TOP KEEPS TRENCH SAFE AND CLEAN DURING  
CONSTRUCTION
- BUILT IN STEEL INSTALLATION DEVICES WON'T BREAK  
AND RESIST FLOTATION
- WIDE ARRAY OF FRAMES AND GRATES
- ANY WIDTH TRENCH
- BUILT IN SLOPE PER SPECIFIED INVERTS
- EASY INSTALLATION

## INSTALLATION DEVICES

- ADJUST TRENCH TO GRADE
- RESIST FLOTATION FORCES
- RIGID METAL BRACKET WON'T  
BREAK OFF DURING CONSTRUCTION

## CONCRETE ANCHORS

- 18" O.C. TYPICAL
- 3" X 3/8" THICK FOR DURABILITY
- EXTENDED SYSTEM LIFE IN  
TRAFFIC APPLICATIONS



## PREFABRICATED TURNS

- SMOOTH INTERIOR
- CONTRACTOR FRIENDLY
- WELDED FRAME

## NOTES:

1. Maximum trench length is only limited by constructability.
2. Standard slope is 0.5% unless specified otherwise.
3. Rectangular bottom trenches are available upon request or per application.



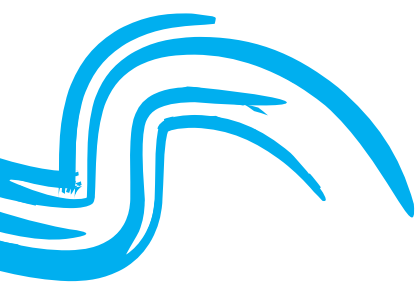

### **INSTALLATION**

- SHIPS FULLY ASSEMBLED
- PLYWOOD TOP FOR SAFETY
- PLYWOOD KEEPS CONCRETE OUT DURING CONSTRUCTION
- EASILY ATTACH BRACES TO WOOD TOP



### **LOAD BEARING FRAME**

- ANY LOAD CONDITION
- MATERIAL OPTIONS INCLUDE:
  - POWDER COATED STEEL
  - GALVANIZED STEEL
  - ALUMINUM
  - CAST IRON
  - PLASTIC
  - FIBERGLASS
  - STAINLESS STEEL
- FACTORY ATTACHED TO BODY

### **SMOOTH RADIUS INTERIOR**

- INCREASED FLOW
- LESS SEDIMENT BUILD-UP

### **SLOPE**

- 0.5% AND 1% SLOPE STANDARD
- CUSTOM SLOPES OFFERED

### **GRATES**

- WIDE VARIETY OF GRATES
- PEDESTRIAN TO AIRCRAFT LOADING
- ADA & HEEL PROOF OPTIONS



The Dura-Trench prefabricated trenches are the work horse of the product line. They are manufactured using GFRPC (Glass fiber reinforced polymer concrete). This is a proprietary blend of polyester resins, UV inhibitors, aggregates, ultra hard ceramic pellets, glass fibers, and pigments. This revolutionary formula makes the trenches extremely durable, lightweight, resistant to most common chemicals, and very easy to install.

These trench systems come in a variety of standard and custom widths, can have any slope, and offer a wide assortment of frames and grates to meet virtually any need.

The system is shipped factory assembled and ready to install. Plywood in the top keeps the frames aligned, coplanar, and debris out. Installation aides are standard. Factory fabricated turns and intersections ensure an easy and precise fit.

Choose a Dura-Trench prefabricated trench system if you need a quality trench system for your next project.



Visit us on the web at [www.trenchdrain.net](http://www.trenchdrain.net) for more information on: Flow rates, chemical resistance, material properties, etc.

# DTPF2



\*shown here with the MDSS frame

## SYSTEM CHARACTERISTICS:

- General Purpose Drain
- Typical for flows up to 0.3 cfs (150 gpm)
- Light debris loading
- Light and medium duty loading

FRAME OPTIONS	LDTP, MDGS, MDSS, MDAL, CUSTOM
GRATES	3" WIDE GRATES
SYSTEM DEPTH	2" - 12" TYP
SECTION LENGTH	8' TYP (16' OR LONGER OPTION)
SLOPE	0.5% & 1% OR SPECIFY INVERTS

## Engineering Specification:

Trench drain shall be DuraTrench as manufactured by Eric'sons, 574C Industrial Way N., Dallas, GA 30132 - (770-505-6575). The trench drain body shall be composed of polyester fiber reinforced polymer concrete. The trench shall have a 2" clear open throat and have a rounded or flat bottom as indicated in details. The trench body shall be gray in color to closely resemble the color of concrete and have a smooth interior for improved flow rates and reduced debris build-up. Sections shall be 96" long (typical) and have a 2" receiving flange on the upstream end for receiving and sealing the trench sections together. Each of the sections shall be labeled to indicate proper flow and placement. The trench body shall mate to the frame and form a grate seat that shall accept the specified grate. The body shall be supplied with a factory fit top for rail alignment and fastening of the channels in the field ensuring that the rails are cast in a coplanar manner. The trench body shall have the following properties: 12,600 psi minimum tensile strength per ASTM C307, 11,600 psi. minimum compressive strength per ASTM C579, 26,500 psi minimum flexural strength per ASTM C580, less than 0.35% water absorption, shall be frost proof, salt proof, and be resistant to dilute acids and alkalis per ASTM C267.

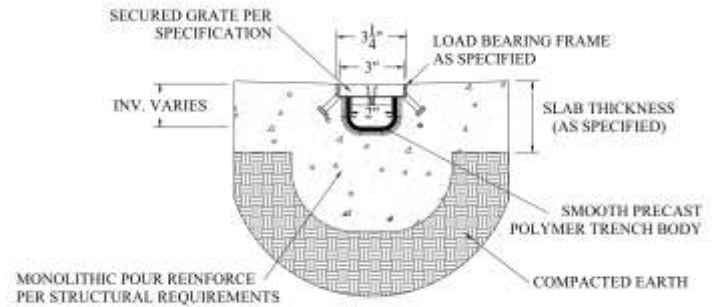

TYPICAL DTPF2 TRENCH SECTION

# DTPF4



\*shown here with the HDBP frame

## SYSTEM CHARACTERISTICS:

- General Purpose Drain - most popular size
- Typical for flows up to 2 cfs (950 gpm)
- Light debris loading
- All load classes

FRAME OPTIONS	LDTP, MDGS, MDSS, MDAL, HDBP, HDGS, HDSS, HDFG, EXGS, EXSS, CUSTOM
GRATES	5" WIDE GRATES
SYSTEM DEPTH	4" - 32" TYP (2" MIN DEPTH WITH RECT BOTTOM)
SECTION LENGTH	8' TYP (16' OR LONGER OPTION)
SLOPE	0.5% & 1% OR SPECIFY INVERTS

## Engineering Specification:

Trench drain shall be DuraTrench as manufactured by Eric'sons, 574C Industrial Way N., Dallas, GA 30132 - (770-505-6575). The trench drain body shall be composed of polyester fiber reinforced polymer concrete. The trench shall have a 4" clear open throat and have a rounded or flat bottom as indicated in details. The trench body shall be gray in color to closely resemble the color of concrete and have a smooth interior for improved flow rates and reduced debris build-up. Sections shall be 96" long (typical) and have a 2" receiving flange on the upstream end for receiving and sealing the trench sections together. Each of the sections shall be labeled to indicate proper flow and placement. The trench body shall mate to the frame and form a grate seat that shall accept the specified grate. The body shall be supplied with a factory fit top for rail alignment and fastening of the channels in the field ensuring that the rails are cast in a coplanar manner. The trench body shall have the following properties: 12,600 psi minimum tensile strength per ASTM C307, 11,600 psi. minimum compressive strength per ASTM C579, 26,500 psi minimum flexural strength per ASTM C580, less than 0.35% water absorption, shall be frost proof, salt proof, and be resistant to dilute acids and alkalis per ASTM C267.

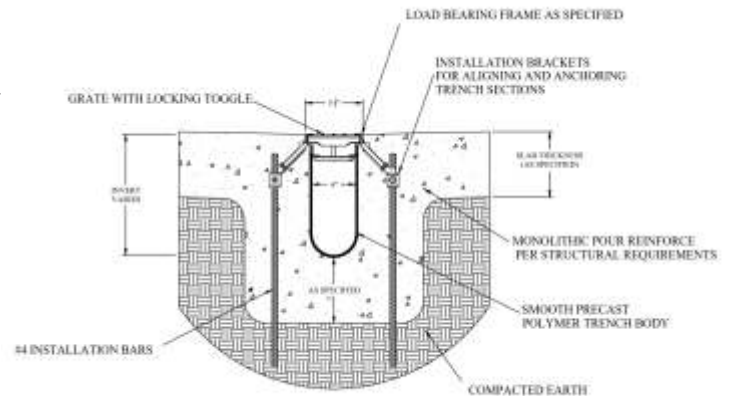

TYPICAL DTPF4 TRENCH SECTION



# DTPF6



\*shown here with the HDSS frame

## SYSTEM CHARACTERISTICS:

- General Purpose Drain
- Typical for flows up to 4 cfs (1800 gpm)
- Light debris loading
- Medium and heavy duty loading

FRAME OPTIONS	MDGS, MDSS, MDAL, HDBP, HDGS, HDSS, HDFG, CUSTOM
GRATES	8" WIDE GRATES
SYSTEM DEPTH	6" - 48" TYP (3" MIN DEPTH WITH RECT BOTTOM)
SECTION LENGTH	8' TYP (16' OR LONGER OPTION)
SLOPE	0.5% & 1% OR SPECIFY INVERTS

## Engineering Specification:

Trench drain shall be DuraTrench as manufactured by Eric'sons, 574C Industrial Way N., Dallas, GA 30132 - (770-505-6575). The trench drain body shall be composed of polyester fiber reinforced polymer concrete. The trench shall have a 6" clear open throat and have a rounded or flat bottom as indicated in details. The trench body shall be gray in color to closely resemble the color of concrete and have a smooth interior for improved flow rates and reduced debris build-up. Sections shall be 96" long (typical) and have a 2" receiving flange on the upstream end for receiving and sealing the trench sections together. Each of the sections shall be labeled to indicate proper flow and placement. The trench body shall mate to the frame and form a grate seat that shall accept the specified grate. The body shall be supplied with a factory fit top for rail alignment and fastening of the channels in the field ensuring that the rails are cast in a coplanar manner. The trench body shall have the following properties: 12,600 psi minimum tensile strength per ASTM C307, 11,600 psi minimum compressive strength per ASTM C579, 26,500 psi minimum flexural strength per ASTM C580, less than 0.35% water absorption, shall be frost proof, salt proof, and be resistant to dilute acids and alkalis per ASTM C267.

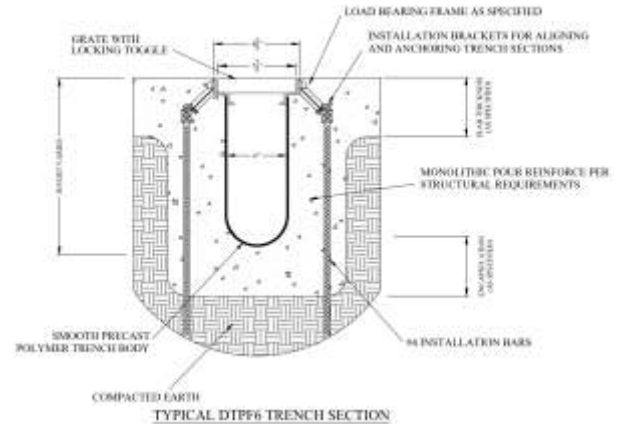

# DTPF8



\*shown here with the HDFG frame

## SYSTEM CHARACTERISTICS:

- General Purpose Drain
- Typical for flows up to 6 cfs (2750 gpm)
- Normal debris loading
- All load classes

FRAME OPTIONS	MDGS, MDSS, MDAL, HDBP, HDGS, HDSS, HDFG, EXGS, EXSS, EXDI, CUSTOM
GRATES	10" WIDE GRATES
SYSTEM DEPTH	6" - 48" TYP (3" MIN DEPTH WITH RECT BOTTOM)
SECTION LENGTH	8' TYP (16' OR LONGER OPTION)
SLOPE	0.5% & 1% OR SPECIFY INVERTS

## Engineering Specification:

Trench drain shall be DuraTrench as manufactured by Eric'sons, 574C Industrial Way N., Dallas, GA 30132 - (770-505-6575). The trench drain body shall be composed of polyester fiber reinforced polymer concrete. The trench shall have a 8" clear open throat and have a rounded or flat bottom as indicated in details. The trench body shall be gray in color to closely resemble the color of concrete and have a smooth interior for improved flow rates and reduced debris build-up. Sections shall be 96" long (typical) and have a 2" receiving flange on the upstream end for receiving and sealing the trench sections together. Each of the sections shall be labeled to indicate proper flow and placement. The trench body shall mate to the frame and form a grate seat that shall accept the specified grate. The body shall be supplied with a factory fit top for rail alignment and fastening of the channels in the field ensuring that the rails are cast in a coplanar manner. The trench body shall have the following properties: 12,600 psi minimum tensile strength per ASTM C307, 11,600 psi minimum compressive strength per ASTM C579, 26,500 psi minimum flexural strength per ASTM C580, less than 0.35% water absorption, shall be frost proof, salt proof, and be resistant to dilute acids and alkalis per ASTM C267.

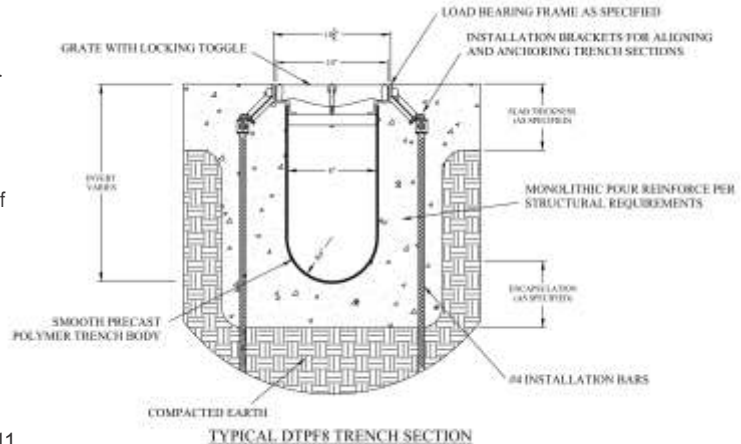

# DTPF10



\*shown here with the EXGS frame

## SYSTEM CHARACTERISTICS:

- General Purpose Drain
- Typical for flows up to 9 cfs (4000 gpm)
- Normal debris loading
- All load classes

FRAME OPTIONS	MDGS, MDSS, MDAL, HDBP, HDGS, HDSS, HDFG, EXGS, EXSS, EXDI, CUSTOM
GRATES	12" WIDE GRATES
SYSTEM DEPTH	6" - 48" TYP (3" MIN DEPTH WITH RECT BOTTOM)
SECTION LENGTH	8' TYP (16' OR LONGER OPTION)
SLOPE	0.5% & 1% OR SPECIFY INVERTS

## Engineering Specification:

Trench drain shall be DuraTrench as manufactured by Eric'sons, 574C Industrial Way N., Dallas, GA 30132 - (770-505-6575). The trench drain body shall be composed of polyester fiber reinforced polymer concrete. The trench shall have a 10" clear open throat and have a rounded or flat bottom as indicated in details. The trench body shall be gray in color to closely resemble the color of concrete and have a smooth interior for improved flow rates and reduced debris build-up. Sections shall be 96" long (typical) and have a 2" receiving flange on the upstream end for receiving and sealing the trench sections together. Each of the sections shall be labeled to indicate proper flow and placement. The trench body shall mate to the frame and form a grate seat that shall accept the specified grate. The body shall be supplied with a factory fit top for rail alignment and fastening of the channels in the field ensuring that the rails are cast in a coplanar manner. The trench body shall have the following properties: 12,600 psi minimum tensile strength per ASTM C307, 11,600 psi. minimum compressive strength per ASTM C579, 26,500 psi minimum flexural strength per ASTM C580, less than 0.35% water absorption, shall be frost proof, salt proof, and be resistant to dilute acids and alkalis per ASTM C267.

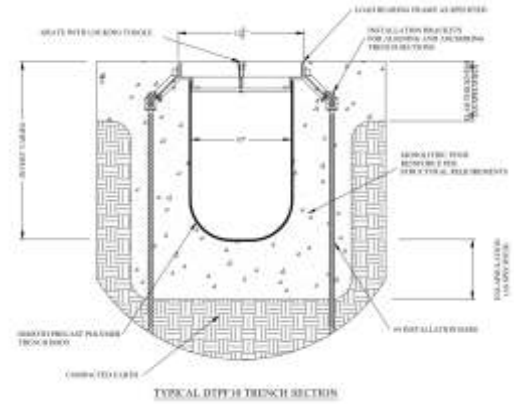

# DTPF12



\*shown here with the HDSS frame

## SYSTEM CHARACTERISTICS:

- General Purpose Drain
- Typical for flows up to 12 cfs (5250 gpm)
- Normal debris loading
- All load classes

FRAME OPTIONS	MDGS, MDSS, MDAL, HDBP, HDGS, HDSS, HDFG, EXGS, EXSS, EXDI, CUSTOM
GRATES	14" WIDE GRATES
SYSTEM DEPTH	6" - 48" TYP (3" MIN DEPTH WITH RECT BOTTOM)
SECTION LENGTH	8' TYP (16' OR LONGER OPTION)
SLOPE	0.5% & 1% OR SPECIFY INVERTS

## Engineering Specification:

Trench drain shall be DuraTrench as manufactured by Eric'sons, 574C Industrial Way N., Dallas, GA 30132 - (770-505-6575). The trench drain body shall be composed of polyester fiber reinforced polymer concrete. The trench shall have a 12" clear open throat and have a rounded or flat bottom as indicated in details. The trench body shall be gray in color to closely resemble the color of concrete and have a smooth interior for improved flow rates and reduced debris build-up. Sections shall be 96" long (typical) and have a 2" receiving flange on the upstream end for receiving and sealing the trench sections together. Each of the sections shall be labeled to indicate proper flow and placement. The trench body shall mate to the frame and form a grate seat that shall accept the specified grate. The body shall be supplied with a factory fit top for rail alignment and fastening of the channels in the field ensuring that the rails are cast in a coplanar manner. The trench body shall have the following properties: 12,600 psi minimum tensile strength per ASTM C307, 11,600 psi. minimum compressive strength per ASTM C579, 26,500 psi minimum flexural strength per ASTM C580, less than 0.35% water absorption, shall be frost proof, salt proof, and be resistant to dilute acids and alkalis per ASTM C267.

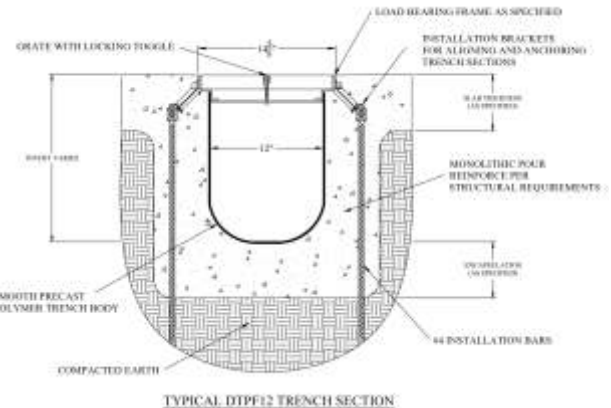

# DTPF18



\*shown here with the HDBP frame

## SYSTEM CHARACTERISTICS:

- General Purpose Drain
- Typical for flows up to 22 cfs (10,000 gpm)
- Heavy debris loading
- All load classes

FRAME OPTIONS	MDGS, MDSS, MDAL, HDBP, HDGS, HDSS, HDFG, EXGS, EXSS, EXDI, CUSTOM
GRATES	20" WIDE GRATES
SYSTEM DEPTH	6" - 48" TYP (3" MIN DEPTH WITH RECT BOTTOM)
SECTION LENGTH	8' TYP (16' OR LONGER OPTION)
SLOPE	0.5% & 1% OR SPECIFY INVERTS

## Engineering Specification:

Trench drain shall be DuraTrench as manufactured by Eric'sons, 574C Industrial Way N., Dallas, GA 30132 - (770-505-6575). The trench drain body shall be composed of polyester fiber reinforced polymer concrete. The trench shall have a 18" clear open throat and have a rounded or flat bottom as indicated in details. The trench body shall be gray in color to closely resemble the color of concrete and have a smooth interior for improved flow rates and reduced debris build-up. Sections shall be 96" long (typical) and have a 2" receiving flange on the upstream end for receiving and sealing the trench sections together. Each of the sections shall be labeled to indicate proper flow and placement. The trench body shall mate to the frame and form a grate seat that shall accept the specified grate. The body shall be supplied with a factory fit top for rail alignment and fastening of the channels in the field ensuring that the rails are cast in a coplanar manner. The trench body shall have the following properties: 12,600 psi minimum tensile strength per ASTM C307, 11,600 psi minimum compressive strength per ASTM C579, 26,500 psi minimum flexural strength per ASTM C580, less than 0.35% water absorption, shall be frost proof, salt proof, and be resistant to dilute acids and alkalis per ASTM C267.

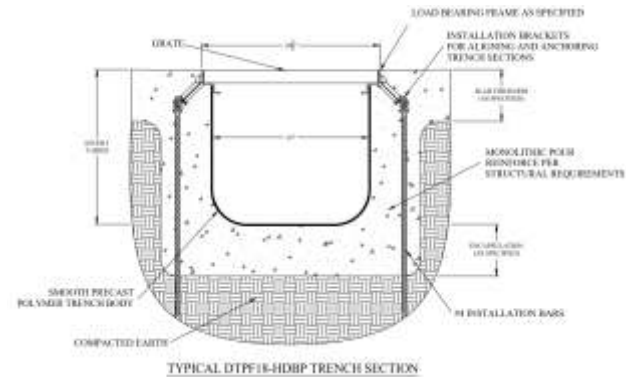

# DTPF24



\*shown here with the HDGS frame

## SYSTEM CHARACTERISTICS:

- General Purpose Drain
- Typical for flows up to 35 cfs (2750 gpm)
- Heavy debris loading
- All load classes

FRAME OPTIONS	MDGS, MDSS, MDAL, HDBP, HDGS, HDSS, HDFG, EXGS, EXSS, EXDI, CUSTOM
GRATES	26" WIDE GRATES
SYSTEM DEPTH	6" - 48" TYP (3" MIN DEPTH WITH RECT BOTTOM)
SECTION LENGTH	8' TYP (16' OR LONGER OPTION)
SLOPE	0.5% & 1% OR SPECIFY INVERTS

## Engineering Specification:

Trench drain shall be DuraTrench as manufactured by Eric'sons, 574C Industrial Way N., Dallas, GA 30132 - (770-505-6575). The trench drain body shall be composed of polyester fiber reinforced polymer concrete. The trench shall have a 24" clear open throat and have a rounded or flat bottom as indicated in details. The trench body shall be gray in color to closely resemble the color of concrete and have a smooth interior for improved flow rates and reduced debris build-up. Sections shall be 96" long (typical) and have a 2" receiving flange on the upstream end for receiving and sealing the trench sections together. Each of the sections shall be labeled to indicate proper flow and placement. The trench body shall mate to the frame and form a grate seat that shall accept the specified grate. The body shall be supplied with a factory fit top for rail alignment and fastening of the channels in the field ensuring that the rails are cast in a coplanar manner. The trench body shall have the following properties: 12,600 psi minimum tensile strength per ASTM C307, 11,600 psi minimum compressive strength per ASTM C579, 26,500 psi minimum flexural strength per ASTM C580, less than 0.35% water absorption, shall be frost proof, salt proof, and be resistant to dilute acids and alkalis per ASTM C267.

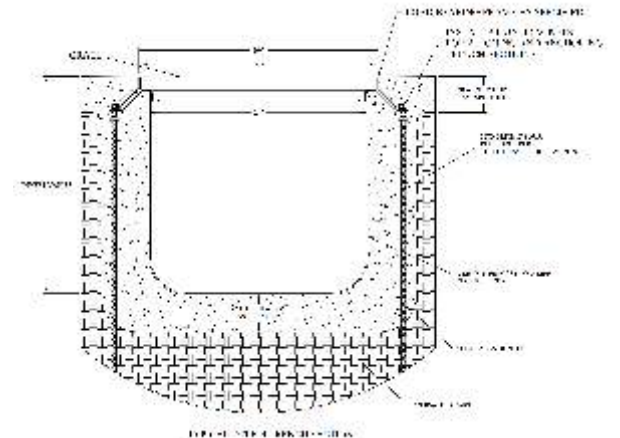



# DTPF36



\*shown here with the HDBP frame

## SYSTEM CHARACTERISTICS:

- General Purpose Drain
- Typical for flows up to 60 cfs (27,000 gpm)
- Heavy debris loading
- All load classes

FRAME OPTIONS	MDGS, MDSS, MDAL, HDBP, HDGS, HDSS, HDFG, EXGS, EXSS, EXDI, CUSTOM
GRATES	38" WIDE GRATES
SYSTEM DEPTH	6" - 48" TYP (3" MIN DEPTH WITH RECT BOTTOM)
SECTION LENGTH	8' TYP (16' OR LONGER OPTION)
SLOPE	0.5% & 1% OR SPECIFY INVERTS

## Engineering Specification:

Trench drain shall be DuraTrench as manufactured by Eric'sons, 574C Industrial Way N., Dallas, GA 30132 - (770-505-6575). The trench drain body shall be composed of polyester fiber reinforced polymer concrete. The trench shall have a 36" clear open throat and have a rounded or flat bottom as indicated in details. The trench body shall be gray in color to closely resemble the color of concrete and have a smooth interior for improved flow rates and reduced debris build-up. Sections shall be 96" long (typical) and have a 2" receiving flange on the upstream end for receiving and sealing the trench sections together. Each of the sections shall be labeled to indicate proper flow and placement. The trench body shall mate to the frame and form a grate seat that shall accept the specified grate. The body shall be supplied with a factory fit top for rail alignment and fastening of the channels in the field ensuring that the rails are cast in a coplanar manner. The trench body shall have the following properties: 12,600 psi minimum tensile strength per ASTM C307, 11,600 psi. minimum compressive strength per ASTM C579, 26,500 psi minimum flexural strength per ASTM C580, less than 0.35% water absorption, shall be frost proof, salt proof, and be resistant to dilute acids and alkalis per ASTM C267.

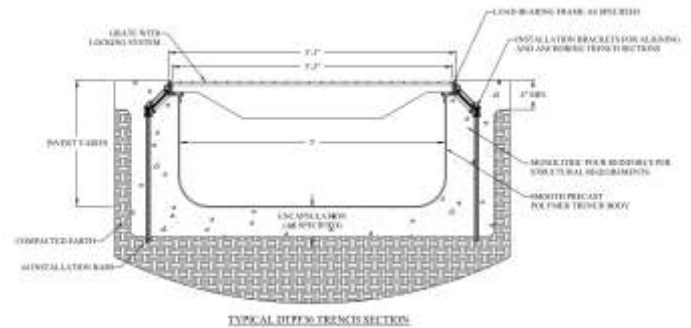

# DTPF48



\*shown here with the HDSS frame

## SYSTEM CHARACTERISTICS:

- General Purpose Drain
- Typical for flows up to 90 cfs (40,000 gpm)
- Heavy debris loading
- All load classes

FRAME OPTIONS	MDGS, MDSS, MDAL, HDBP, HDGS, HDSS, HDFG, EXGS, EXSS, EXDI, CUSTOM
GRATES	50" WIDE GRATES
SYSTEM DEPTH	6" - 48" TYP (3" MIN DEPTH WITH RECT BOTTOM)
SECTION LENGTH	8' TYP (16' OR LONGER OPTION)
SLOPE	0.5% & 1% OR SPECIFY INVERTS

## Engineering Specification:

Trench drain shall be DuraTrench as manufactured by Eric'sons, 574C Industrial Way N., Dallas, GA 30132 - (770-505-6575). The trench drain body shall be composed of polyester fiber reinforced polymer concrete. The trench shall have a 48" clear open throat and have a rounded or flat bottom as indicated in details. The trench body shall be gray in color to closely resemble the color of concrete and have a smooth interior for improved flow rates and reduced debris build-up. Sections shall be 96" long (typical) and have a 2" receiving flange on the upstream end for receiving and sealing the trench sections together. Each of the sections shall be labeled to indicate proper flow and placement. The trench body shall mate to the frame and form a grate seat that shall accept the specified grate. The body shall be supplied with a factory fit top for rail alignment and fastening of the channels in the field ensuring that the rails are cast in a coplanar manner. The trench body shall have the following properties: 12,600 psi minimum tensile strength per ASTM C307, 11,600 psi. minimum compressive strength per ASTM C579, 26,500 psi minimum flexural strength per ASTM C580, less than 0.35% water absorption, shall be frost proof, salt proof, and be resistant to dilute acids and alkalis per ASTM C267.

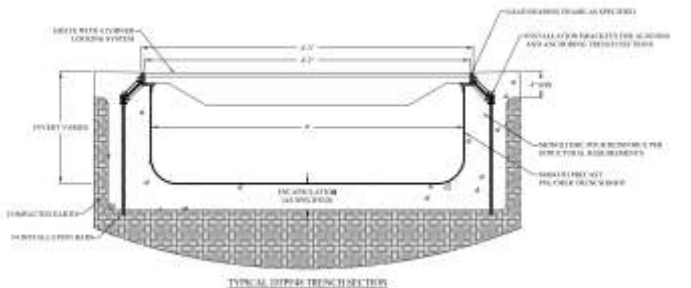

# CUSTOM OPTIONS



**END TREATMENTS**



**DOUBLE CONTAINMENT**



**SPECIAL PROFILES**

**INTERNAL WIERS**



**SIDE BY SIDE DRAINS**



**CUSTOM FRAMES**

**FLOW CONTROL DESIGNS**



**CLAMPING COLLARS**

**YOU DREAM IT - WE BUILD IT!**

# SLOTTED DRAIN (DTSP)

## LOAD BEARING FRAME

- FRAME WITH STUDS TRANSFERS LOAD TO SURROUNDING CONCRETE NOT TO SLOT DRAIN BODY.
- HEEL PROOF, ADA COMPLIANT SLOT OFFERED OR HIGH FLOW BICYCLE SAFE
- MATERIAL OPTIONS INCLUDE:
  - POWDER COATED STEEL
  - GALVANIZED STEEL
  - STAINLESS STEEL

## JOINTS

- LARGE 2" INTEGRAL BELL CONNECTIONS
- WATERTIGHT SEAL ATTAINABLE WITH APPROPRIATE SEALANT

## SMOOTH INTERIOR

- INCREASED FLOWS
- LESS SEDIMENT BUILD-UP

## VARIABLE HEIGHT RISER

- 0.5% AND 1% SLOPE STANDARD
- CUSTOM SLOPES OFFERED

## INSTALLATION DEVICES

- ADJUST SLOT PIPE TO GRADE
- RESIST FLOTATION FORCES
- RIGID METAL BRACKET WON'T BREAK DURING CONSTRUCTION



## SLOT PIPE BODY

- 10' LENGTHS TYPICAL
- DIAMETERS OF 4", 6", 8", 12", 15", 18", 21", 24", AND 36"
- CUSTOM SLOT AND PIPE WIDTHS

**STANDARD SIZES**  
**4", 6", 8", 12", 15",**  
**18", 21", 24", 36"**



The Dura-Trench slot drain system is a modern advancement of the classic metal slot drain system. The interior of the DuraTrench slot drain is ultra-smooth to increase flow rates and reduce debris build up. With proper slope, scouring velocities are easily achieved. The heavy duty frames have an external flange and concrete anchors to provide proper bearing area for load transfer into the concrete. This is very important for the long term durability of a slot drain in heavy traffic applications. Unlike other slot drain designs, the load is transferred to the concrete instead of the slot pipe body. The Dura Trench slot drain comes standard with installation devices. These installation devices offer a way to level the slot drain and assist in anchoring and aligning the slot drain. The installation aides ensure proper concrete consolidation under the slot drain can be achieved. Variable height risers are also standard. This gives the designer the desired slope, flow, and cleaning velocities.



## Dura-Trench Slot Pipe

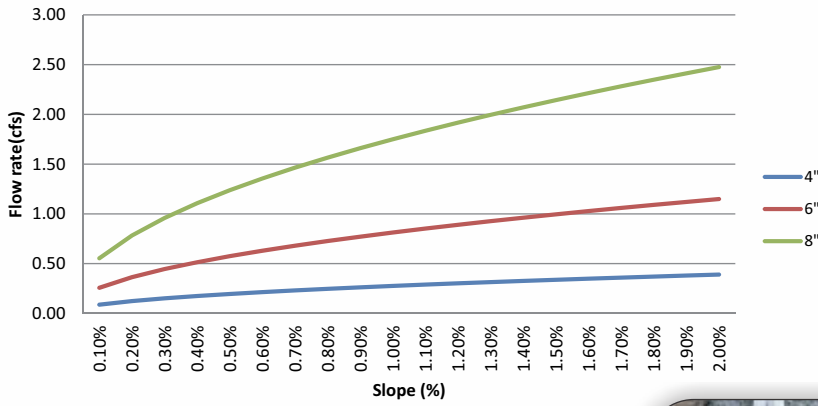

Slotted drains typically outlet with a pipe out the end or by using a catch basin. The Dura-Trench system is offered with any size outlet pipe connection desired, molded directly into the system for easy field connection to the drainage piping system.

Clean-out chambers are offered for access to the slot drain at strategic locations. It is recommended that clean out chambers be placed at any turns, intersections, and at 100' intervals in the slot drain system to aid in the system maintenance.

## Dura-Trench Slot Pipe

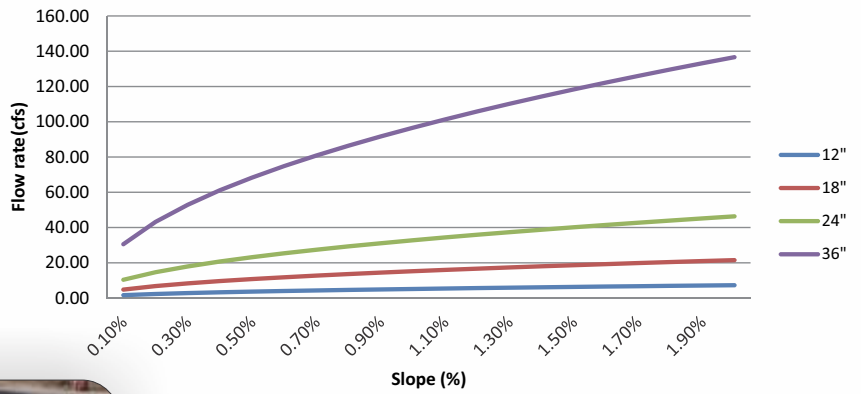

Slot drain applications include parks, roads, fountains, aircraft parking aprons, loading docks, industrial areas, and numerous others. The slot drain pipes can be very large to extremely small depending on the required flows. The slot opening can be configured for ADA compliance & heel proof requirements. The low profile high flow slot drain is a reliable and long lasting linear drain option.

# DTSP4



\*shown here with the MDSPAL frame

## SYSTEM CHARACTERISTICS:

- General Purpose Drain
- Typical for flows up to 0.25 cfs (110 gpm)
- Light debris loading
- All load classes

FRAME OPTIONS	MDSPBP, MDSPAL, MDSPGS, MDSPSS, HDSPBP, HDSPGS, HDSPSS, CUSTOM
SYSTEM DEPTH	6" - 34" TYP
SECTION LENGTH	10' TYP (20' OPTION)
SLOPE	0.5% & 1% OR SPECIFY INVERTS

## Engineering Specification:

Slotted Pipe shall be DuraTrench as manufactured by Eric'sons, 574C Industrial Way N., Dallas, GA 30132 - (770-505-6575). The slot pipe body shall be composed of polyester fiber reinforced polymer concrete. The slot pipe body shall have an internal dimension of 4" and have a smooth interior for improved flow rates and reduced debris build-up. Sections shall be 120" long (typical), have a variable height riser with a 0.5% slope minimum (or as indicated on the plans), and have a 2" receiving flange on the upstream end for receiving the previous slot drain section. Each of the sections shall be labeled to indicate proper flow and placement. The slot pipe body shall mate to the load bearing frame. The slot pipe body shall have the following properties: 12,600 psi minimum tensile strength per ASTM C307, 11,600 psi. minimum compressive strength per ASTM C579, 26,500 psi minimum flexural strength per ASTM C580, less than 0.35% water absorption, shall be frost proof, salt proof, and be resistant to dilute acids and alkalis per ASTM C267.

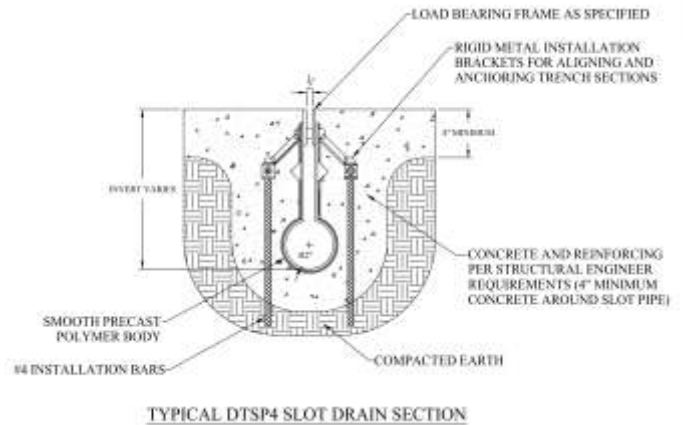

# DTOSSP4



\*shown here with the MDSPSS frame

## SYSTEM CHARACTERISTICS:

- Specialty Drain
- Typical for flows up to 0.25 cfs (110 gpm)
- Light debris loading
- Light loading

FRAME OPTIONS	MDSPBP, MDSPAL, MDSPGS, CUSTOM
SYSTEM DEPTH	6" - 34" TYP
SECTION LENGTH	10' TYP (20' OPTION)
SLOPE	0.5% & 1% OR SPECIFY INVERTS

## Engineering Specification:

Slotted Pipe shall be DuraTrench as manufactured by Eric'sons, 574C Industrial Way N., Dallas, GA 30132 - (770-505-6575). The slot pipe body shall be composed of polyester fiber reinforced polymer concrete. The slot pipe body shall have an internal dimension of 4" and have a smooth interior for improved flow rates and reduced debris build-up. The throat shall be offset so the drain can be closely placed against a vertical obstruction. Sections shall be 120" long (typical), have a variable height riser with a 0.5% slope minimum (or as indicated on the plans), and have a 2" receiving flange on the upstream end for receiving the previous slot drain section. Each of the sections shall be labeled to indicate proper flow and placement. The slot pipe body shall mate to the load bearing frame. The slot pipe body shall have the following properties: 12,600 psi minimum tensile strength per ASTM C307, 11,600 psi. minimum compressive strength per ASTM C579, 26,500 psi minimum flexural strength per ASTM C580, less than 0.35% water absorption, shall be frost proof, salt proof, and be resistant to dilute acids and alkalis per ASTM C267.

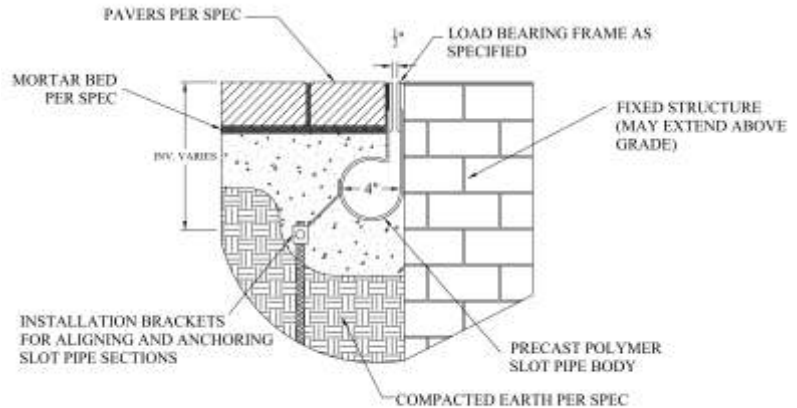

# DTSP6



\*shown here with the HDSPBP frame

## Engineering Specification:

Slotted Pipe shall be DuraTrench as manufactured by Eric'sons, 574C Industrial Way N., Dallas, GA 30132 - (770-505-6575). The slot pipe body shall be composed of polyester fiber reinforced polymer concrete. The slot pipe body shall have an internal dimension of 6" and have a smooth interior for improved flow rates and reduced debris build-up. Sections shall be 120" long (typical), have a variable height riser with a 0.5% slope minimum (or as indicated on the plans), and have a 2" receiving flange on the upstream end for receiving the previous slot drain section. Each of the sections shall be labeled to indicate proper flow and placement. The slot pipe body shall mate to the load bearing frame. The slot pipe body shall have the following properties: 12,600 psi minimum tensile strength per ASTM C307, 11,600 psi. minimum compressive strength per ASTM C579, 26,500 psi minimum flexural strength per ASTM C580, less than 0.35% water absorption, shall be frost proof, salt proof, and be resistant to dilute acids and alkalis per ASTM C267.

## SYSTEM CHARACTERISTICS:

- General Purpose Drain
- Typical for flows up to 0.8 cfs (350 gpm)
- Light debris loading
- All load classes

FRAME OPTIONS	MDSPBP, MDSPAL, MDSPGS, MDSPSS, HDSPBP, HDSPGS, HDSPSS, CUSTOM
SYSTEM DEPTH	8" - 36" TYP
SECTION LENGTH	10' TYP (20' OPTION)
SLOPE	0.5% & 1% OR SPECIFY INVERTS

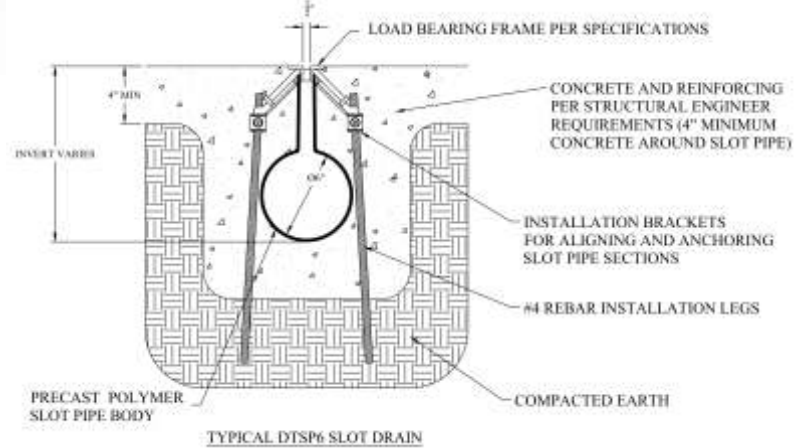

# DTOSSP6



\*shown here with the MDSPBP frame

## Engineering Specification:

Slotted Pipe shall be DuraTrench as manufactured by Eric'sons, 574C Industrial Way N., Dallas, GA 30132 - (770-505-6575). The slot pipe body shall be composed of polyester fiber reinforced polymer concrete. The slot pipe body shall have an internal dimension of 6" and have a smooth interior for improved flow rates and reduced debris build-up. The throat shall be offset so the drain can be closely placed against a vertical obstruction. Sections shall be 120" long (typical), have a variable height riser with a 0.5% slope minimum (or as indicated on the plans), and have a 2" receiving flange on the upstream end for receiving the previous slot drain section. Each of the sections shall be labeled to indicate proper flow and placement. The slot pipe body shall mate to the load bearing frame. The slot pipe body shall have the following properties: 12,600 psi minimum tensile strength per ASTM C307, 11,600 psi. minimum compressive strength per ASTM C579, 26,500 psi minimum flexural strength per ASTM C580, less than 0.35% water absorption, shall be frost proof, salt proof, and be resistant to dilute acids and alkalis per ASTM C267.

## SYSTEM CHARACTERISTICS:

- Specialty Drain
- Typical for flows up to 0.8 cfs (350 gpm)
- Light debris loading
- Light loading

FRAME OPTIONS	MDSPBP, MDSPAL, MDSPGS, CUSTOM
SYSTEM DEPTH	8" - 36" TYP
SECTION LENGTH	10' TYP (20' OPTION)
SLOPE	0.5% & 1% OR SPECIFY INVERTS

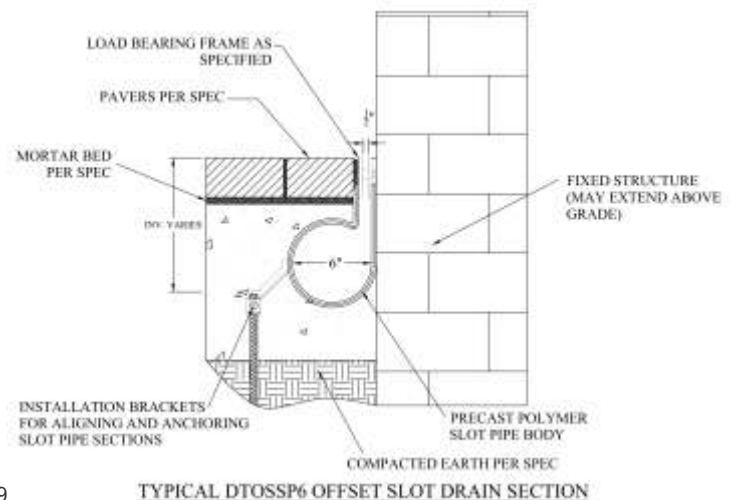



# DTSP8



\*shown here with the EXSPSS frame

## SYSTEM CHARACTERISTICS:

- General Purpose Drain
- Typical for flows up to 1.75 cfs (775 gpm)
- Moderate debris loading
- All load classes

FRAME OPTIONS	HDSPBP, HDSPGS, HDSPSS, EXBP, EXGS, EXSS, CUSTOM
SYSTEM DEPTH	11" - 44" TYP
SECTION LENGTH	10' TYP (20' OPTION)
SLOPE	0.5% & 1% OR SPECIFY INVERTS

## Engineering Specification:

Slotted Pipe shall be DuraTrench as manufactured by Eric'sons, 574C Industrial Way N., Dallas, GA 30132 - (770-505-6575). The slot pipe body shall be composed of polyester fiber reinforced polymer concrete. The slot pipe body shall have an internal dimension of 8" and have a smooth interior for improved flow rates and reduced debris build-up. Sections shall be 120" long (typical), have a variable height riser with a 0.5% slope minimum (or as indicated on the plans), and have a 2" receiving flange on the upstream end for receiving the previous slot drain section. Each of the sections shall be labeled to indicate proper flow and placement. The slot pipe body shall mate to the load bearing frame. The slot pipe body shall have the following properties: 12,600 psi minimum tensile strength per ASTM C307, 11,600 psi minimum compressive strength per ASTM C579, 26,500 psi minimum flexural strength per ASTM C580, less than 0.35% water absorption, shall be frost proof, salt proof, and be resistant to dilute acids and alkalis per ASTM C267.

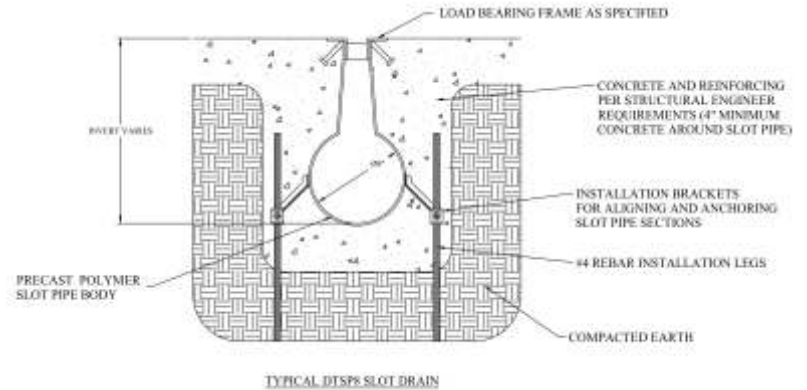

# DTSP12



\*shown here with the HDSPBP frame

## SYSTEM CHARACTERISTICS:

- General Purpose Drain
- Typical for flows up to 5 cfs (2250 gpm)
- Moderate debris loading
- All load classes

FRAME OPTIONS	HDSPBP, HDSPGS, HDSPSS, EXBP, EXGS, EXSS, CUSTOM
SYSTEM DEPTH	15" - 48" TYP
SECTION LENGTH	10' TYP (20' OPTION)
SLOPE	0.5% & 1% OR SPECIFY INVERTS

## Engineering Specification:

Slotted Pipe shall be DuraTrench as manufactured by Eric'sons, 574C Industrial Way N., Dallas, GA 30132 - (770-505-6575). The slot pipe body shall be composed of polyester fiber reinforced polymer concrete. The slot pipe body shall have an internal dimension of 12" and have a smooth interior for improved flow rates and reduced debris build-up. Sections shall be 120" long (typical), have a variable height riser with a 0.5% slope minimum (or as indicated on the plans), and have a 2" receiving flange on the upstream end for receiving the previous slot drain section. Each of the sections shall be labeled to indicate proper flow and placement. The slot pipe body shall mate to the load bearing frame. The slot pipe body shall have the following properties: 12,600 psi minimum tensile strength per ASTM C307, 11,600 psi minimum compressive strength per ASTM C579, 26,500 psi minimum flexural strength per ASTM C580, less than 0.35% water absorption, shall be frost proof, salt proof, and be resistant to dilute acids and alkalis per ASTM C267.

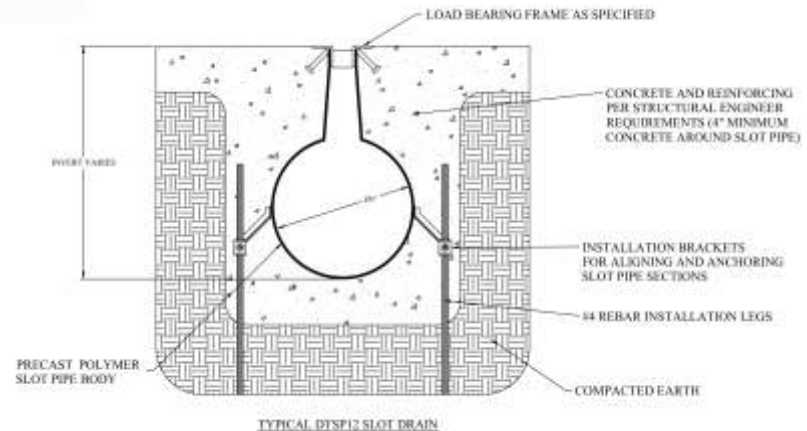

# DTSP15



\*shown here with the HDSPGS frame

## SYSTEM CHARACTERISTICS:

- General Purpose Drain
- Typical for flows up to 9 cfs (4000 gpm)
- Moderate debris loading
- All load classes

FRAME OPTIONS	HDSPBP, HDSPGS, HDSPSS, EXBP, EXGS, EXSS, CUSTOM
SYSTEM DEPTH	18" - 51" TYP
SECTION LENGTH	10' TYP (20' OPTION)
SLOPE	0.5% & 1% OR SPECIFY INVERTS

## Engineering Specification:

Slotted Pipe shall be DuraTrench as manufactured by Eric'sons, 574C Industrial Way N., Dallas, GA 30132 - (770-505-6575). The slot pipe body shall be composed of polyester fiber reinforced polymer concrete. The slot pipe body shall have an internal dimension of 15" and have a smooth interior for improved flow rates and reduced debris build-up. Sections shall be 120" long (typical), have a variable height riser with a 0.5% slope minimum (or as indicated on the plans), and have a 2" receiving flange on the upstream end for receiving the previous slot drain section. Each of the sections shall be labeled to indicate proper flow and placement. The slot pipe body shall mate to the load bearing frame. The slot pipe body shall have the following properties: 12,600 psi minimum tensile strength per ASTM C307, 11,600 psi. minimum compressive strength per ASTM C579, 26,500 psi minimum flexural strength per ASTM C580, less than 0.35% water absorption, shall be frost proof, salt proof, and be resistant to dilute acids and alkalis per ASTM C267.

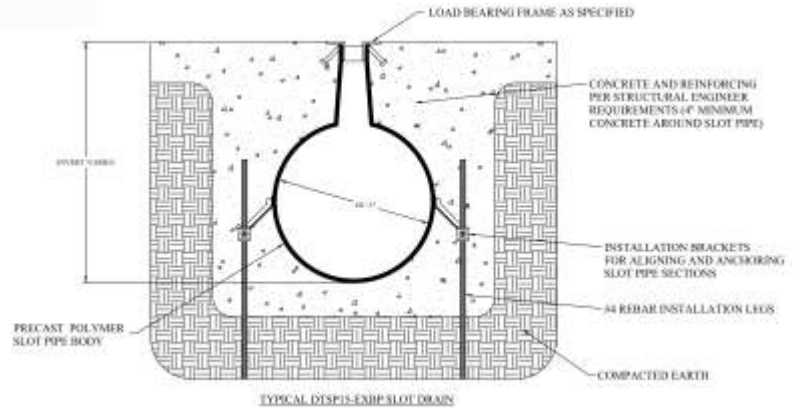

# DTSP18



\*shown here with the EXSPBP frame

## SYSTEM CHARACTERISTICS:

- General Purpose Drain
- Typical for flows up to 15 cfs (6750 gpm)
- Moderate debris loading
- All load classes

FRAME OPTIONS	HDSPBP, HDSPGS, HDSPSS, EXBP, EXGS, EXSS, CUSTOM
SYSTEM DEPTH	21" - 54" TYP
SECTION LENGTH	10' TYP (20' OPTION)
SLOPE	0.5% & 1% OR SPECIFY INVERTS

## Engineering Specification:

Slotted Pipe shall be DuraTrench as manufactured by Eric'sons, 574C Industrial Way N., Dallas, GA 30132 - (770-505-6575). The slot pipe body shall be composed of polyester fiber reinforced polymer concrete. The slot pipe body shall have an internal dimension of 18" and have a smooth interior for improved flow rates and reduced debris build-up. Sections shall be 120" long (typical), have a variable height riser with a 0.5% slope minimum (or as indicated on the plans), and have a 2" receiving flange on the upstream end for receiving the previous slot drain section. Each of the sections shall be labeled to indicate proper flow and placement. The slot pipe body shall mate to the load bearing frame. The slot pipe body shall have the following properties: 12,600 psi minimum tensile strength per ASTM C307, 11,600 psi. minimum compressive strength per ASTM C579, 26,500 psi minimum flexural strength per ASTM C580, less than 0.35% water absorption, shall be frost proof, salt proof, and be resistant to dilute acids and alkalis per ASTM C267.

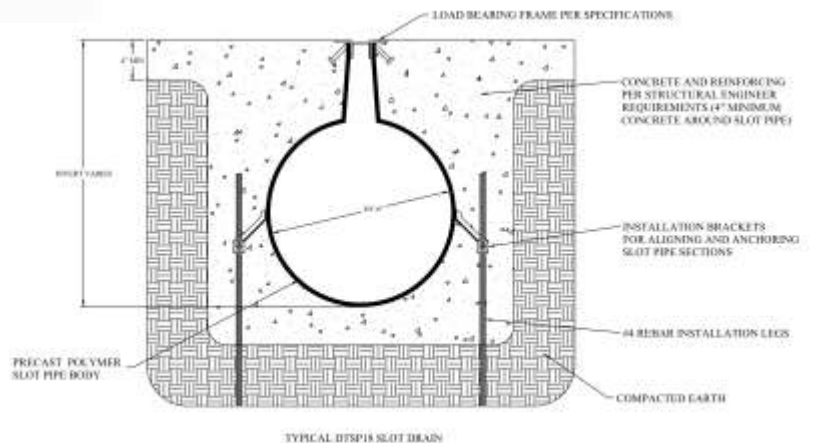

# DTSP21



\*shown here with the EXSPSS frame

## SYSTEM CHARACTERISTICS:

- General Purpose Drain
- Typical for flows up to 23 cfs (10,300 gpm)
- Heavy debris loading
- All load classes

FRAME OPTIONS	HDSPBP, HDSPGS, HDSPSS, EXBP, EXGS, EXSS, CUSTOM
SYSTEM DEPTH	24" - 57" TYP
SECTION LENGTH	10' TYP (20' OPTION)
SLOPE	0.5% & 1% OR SPECIFY INVERTS

## Engineering Specification:

Slotted Pipe shall be DuraTrench as manufactured by Eric'sons, 574C Industrial Way N., Dallas, GA 30132 - (770-505-6575). The slot pipe body shall be composed of polyester fiber reinforced polymer concrete. The slot pipe body shall have an internal dimension of 21" and have a smooth interior for improved flow rates and reduced debris build-up. Sections shall be 120" long (typical), have a variable height riser with a 0.5% slope minimum (or as indicated on the plans), and have a 2" receiving flange on the upstream end for receiving the previous slot drain section. Each of the sections shall be labeled to indicate proper flow and placement. The slot pipe body shall mate to the load bearing frame. The slot pipe body shall have the following properties: 12,600 psi minimum tensile strength per ASTM C307, 11,600 psi minimum compressive strength per ASTM C579, 26,500 psi minimum flexural strength per ASTM C580, less than 0.35% water absorption, shall be frost proof, salt proof, and be resistant to dilute acids and alkalis per ASTM C267.

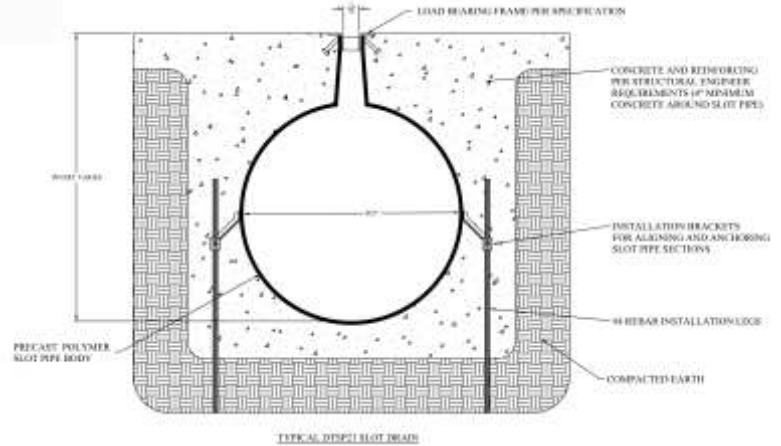

# DTSP24



\*shown here with the HDSPBP frame

## SYSTEM CHARACTERISTICS:

- General Purpose Drain
- Typical for flows up to 32 cfs (14,250 gpm)
- Heavy debris loading
- All load classes

FRAME OPTIONS	HDSPBP, HDSPGS, HDSPSS, EXBP, EXGS, EXSS, CUSTOM
SYSTEM DEPTH	27" - 60" TYP
SECTION LENGTH	10' TYP (20' OPTION)
SLOPE	0.5% & 1% OR SPECIFY INVERTS

## Engineering Specification:

Slotted Pipe shall be DuraTrench as manufactured by Eric'sons, 574C Industrial Way N., Dallas, GA 30132 - (770-505-6575). The slot pipe body shall be composed of polyester fiber reinforced polymer concrete. The slot pipe body shall have an internal dimension of 24" and have a smooth interior for improved flow rates and reduced debris build-up. Sections shall be 120" long (typical), have a variable height riser with a 0.5% slope minimum (or as indicated on the plans), and have a 2" receiving flange on the upstream end for receiving the previous slot drain section. Each of the sections shall be labeled to indicate proper flow and placement. The slot pipe body shall mate to the load bearing frame. The slot pipe body shall have the following properties: 12,600 psi minimum tensile strength per ASTM C307, 11,600 psi minimum compressive strength per ASTM C579, 26,500 psi minimum flexural strength per ASTM C580, less than 0.35% water absorption, shall be frost proof, salt proof, and be resistant to dilute acids and alkalis per ASTM C267.

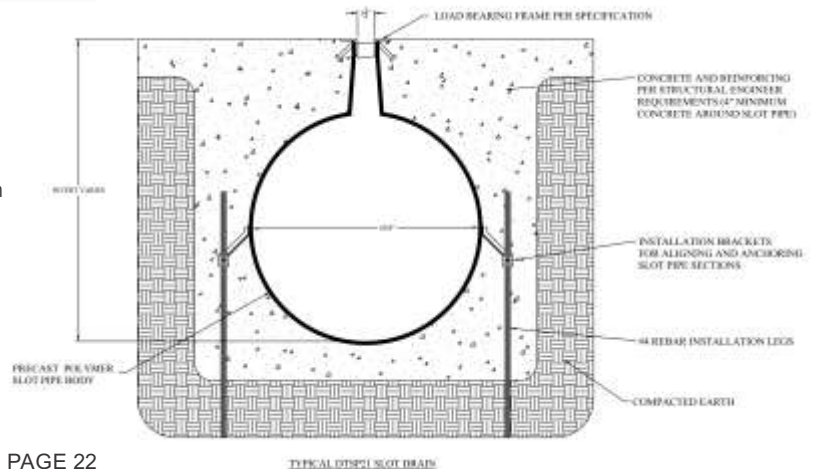



# DTSP36



## SYSTEM CHARACTERISTICS:

- General Purpose Drain
- Typical for flows up to 96 cfs (43,000 gpm)
- Heavy debris loading
- All load classes

FRAME OPTIONS	HDSPBP, HDSPGS, HDSPSS, EXBP, EXGS, EXSS, CUSTOM
SYSTEM DEPTH	39" - 72" TYP
SECTION LENGTH	10' TYP (20' OPTION)
SLOPE	0.5% & 1% OR SPECIFY INVERTS

### Engineering Specification:

Slotted Pipe shall be DuraTrench as manufactured by Eric'sons, 574C Industrial Way N., Dallas, GA 30132 - (770-505-6575). The slot pipe body shall be composed of polyester fiber reinforced polymer concrete. The slot pipe body shall have an internal dimension of 36" and have a smooth interior for improved flow rates and reduced debris build-up. Sections shall be 120" long (typical), have a variable height riser with a 0.5% slope minimum (or as indicated on the plans), and have a 2" receiving flange on the upstream end for receiving the previous slot drain section. Each of the sections shall be labeled to indicate proper flow and placement. The slot pipe body shall mate to the load bearing frame. The slot pipe body shall have the following properties: 12,600 psi minimum tensile strength per ASTM C307, 11,600 psi. minimum compressive strength per ASTM C579, 26,500 psi minimum flexural strength per ASTM C580, less than 0.35% water absorption, shall be frost proof, salt proof, and be resistant to dilute acids and alkalis per ASTM C267.

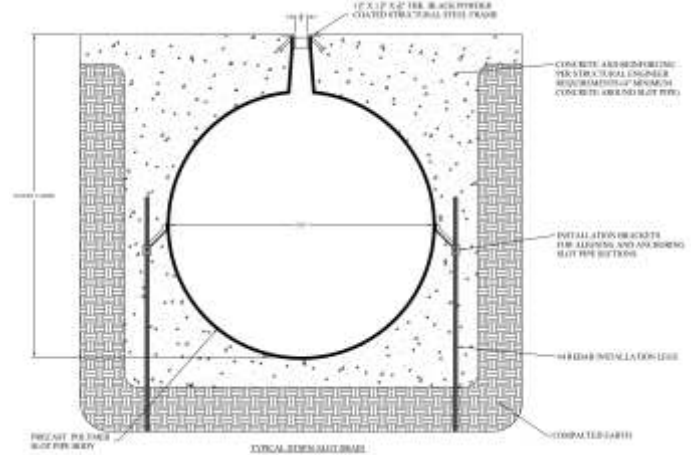

# CLEAN OUT PORTS

### FRAMES TO MATCH SYSTEM

- ALL FRAME MATERIALS AND FINISHES OFFERED
- WELDED TO SLOT PIPE FRAME

### NUMEROUS GRATE OPTIONS

- CHOOSE ANY SIZE OR STYLE GRATE
- GRATES CAN BE LOCKED IN PLACE

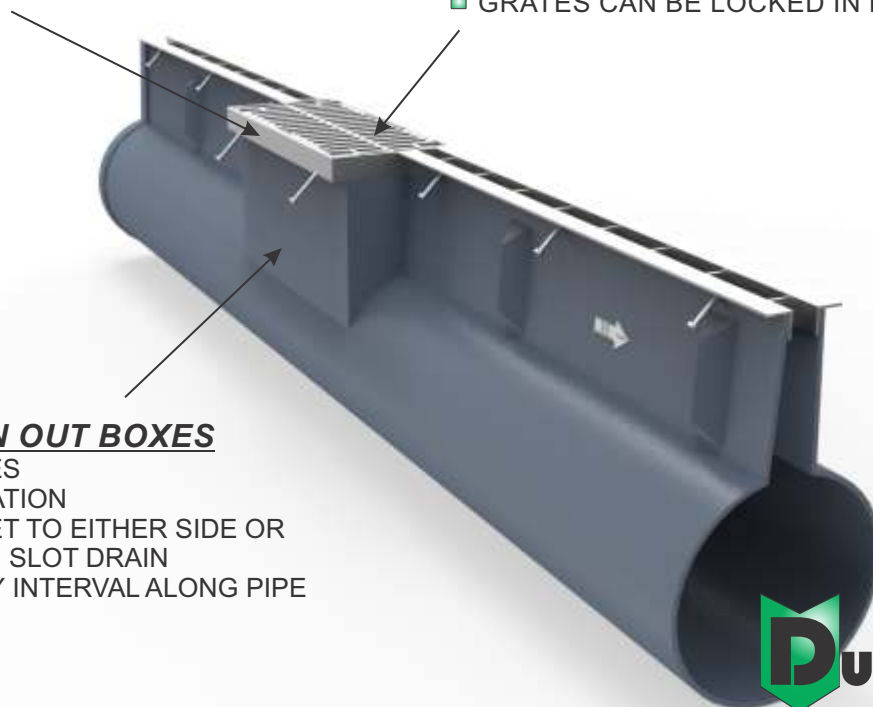

### INTEGRAL CLEAN OUT BOXES

- MULTIPLE SIZES
- FAST INSTALLATION
- CAN BE OFFSET TO EITHER SIDE OR CENTERED ON SLOT DRAIN
- CAN BE AT ANY INTERVAL ALONG PIPE



# TRUE RADIUS TRENCHES (DTRPF)

## STANDARD

**SIZES**

**2" ID**

**4" ID**

**6" ID**

**8" ID**

**10" ID**

**12" ID**

**18" ID**

**24" ID**



**Dura Trench**  
manufactured by Eric'sons  
**RADIUS DRAINS**

## RADIUS TRENCHES

- TRUE RADIUS TRENCH
- ANY RADIUS
- GRATE OPTIONS INCLUDE ALUMINUM, STAINLESS STEEL, GALVANIZED STEEL, DUCTILE IRON, BRONZE, PLASTIC, STONE
- WIDE ARRAY OF GRATE PATTERNS
- ANY WIDTH TRENCH
- DURABLE PREFABRICATED BODY
- EASY INSTALLATION

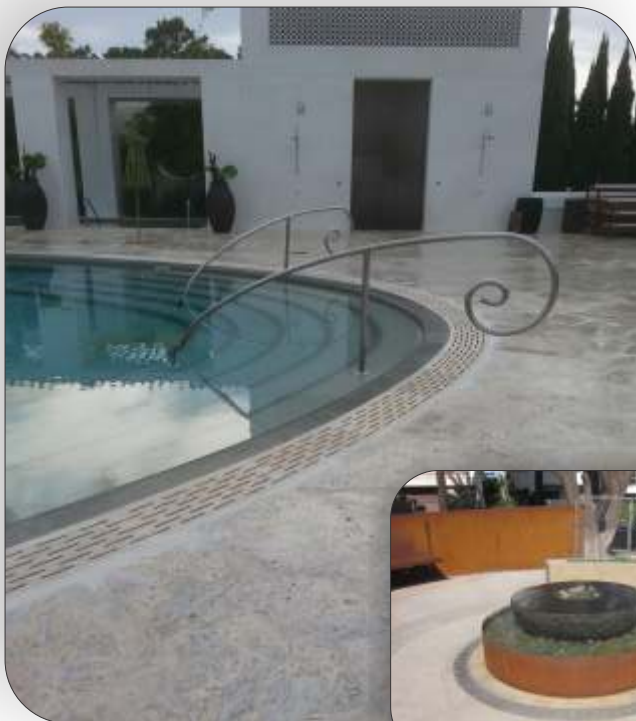



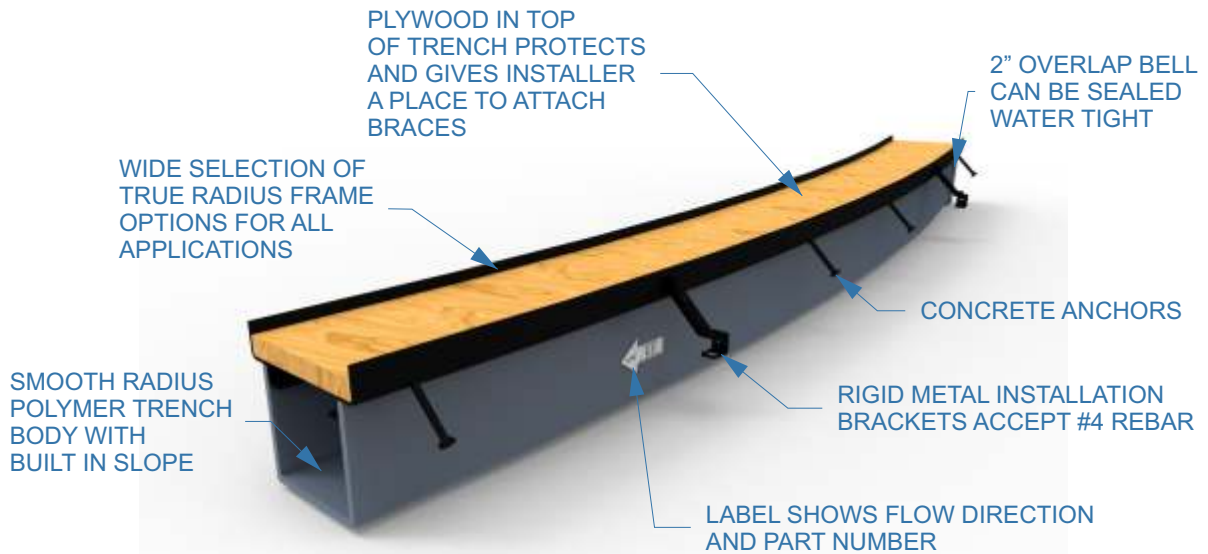

We are the premier manufacturer of true radius trench drains  
 Standard widths are 2", 4", 6", 8", 10", 12", 18", 24"  
 Any radius can be specified.  
 Standard lengths are 8' long with smooth radius for fast installation!



Dura-Trench offers custom built radius trenches to the customer's specifications. The possibilities are limitless and any design or concept can be achieved with this system. Frames and grates can be virtually any material. With the prefabricated trench bodies it makes the construction easy for contractors of any skill level. By specifying Dura-Trench you are sure to get the look you want.

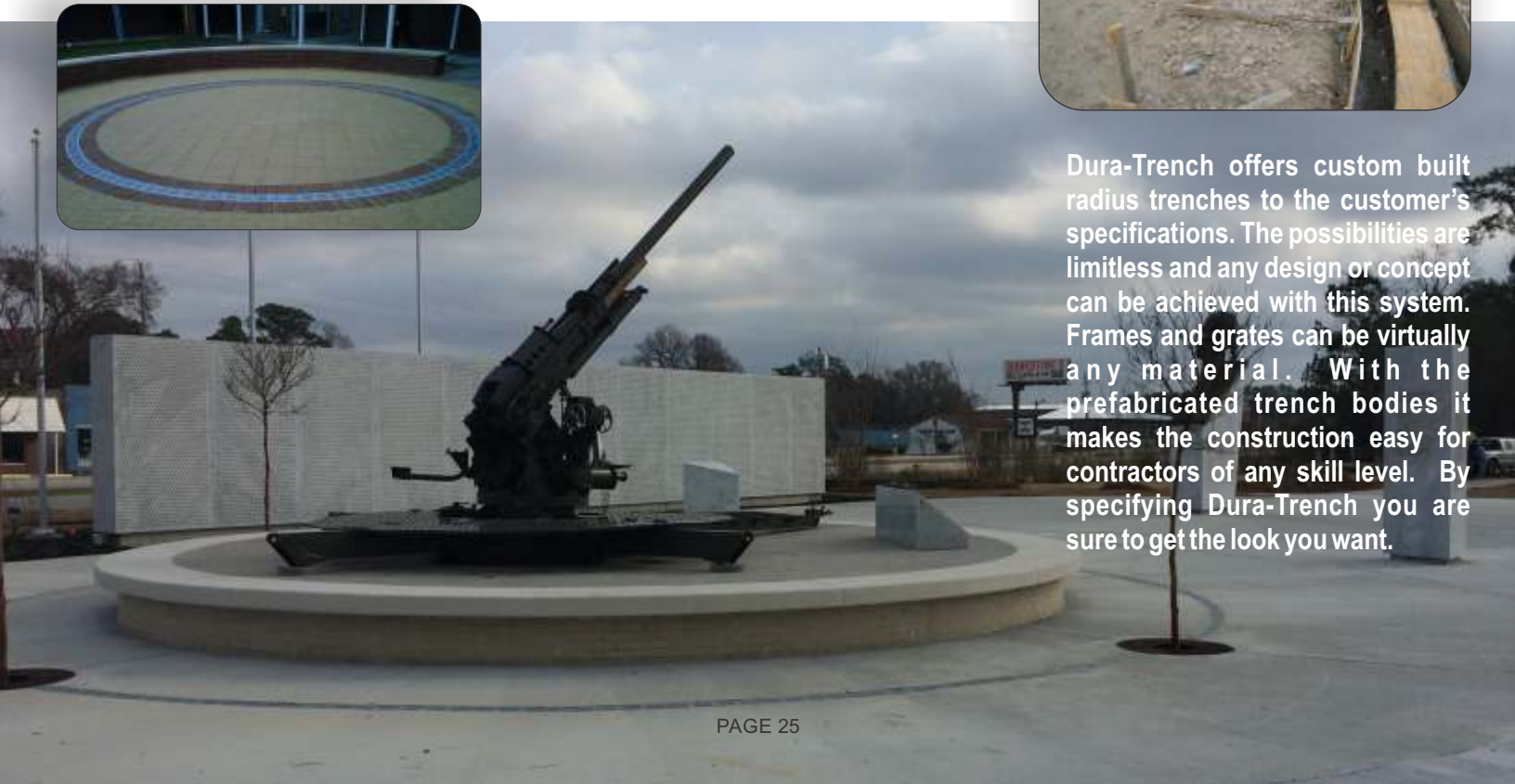



# RADIUS SLOT PIPE (DTRSP)

**STANDARD  
SIZES**  
4" ID  
6" ID  
8" ID  
10" ID

The beauty of a slot drain is that it can be almost invisible



## RADIUS SLOT PIPE

- TRUE RADIUS SLOT PIPE
- ANY RADIUS
- FRAME OPTIONS INCLUDE ALUMINUM, STAINLESS STEEL, GALVANIZED STEEL, DUCTILE IRON, BRONZE, PLASTIC
- CAN HAVE OFFSET THROAT FOR PLACEMENT FLUSH AGAINST STRUCTURES
- DURABLE PREFABRICATED BODY
- EASY INSTALLATION



**Dura Trench**  
manufactured by Eric'ron/  
**RADIUS SLOT PIPE**





**LOAD BEARING FRAME**

- NARROW REVEAL FRAME OR HEAVY DUTY WIDE LOAD TRANSFER FRAMES OFFERED.
- HEEL PROOF, ADA COMPLIANT SLOT OFFERED OR HIGH FLOW BICYCLE SAFE

**JOINTS**

- LARGE 2" INTEGRAL BELL CONNECTIONS
- WATERTIGHT SEAL ATTAINABLE WITH APPROPRIATE SEALANT

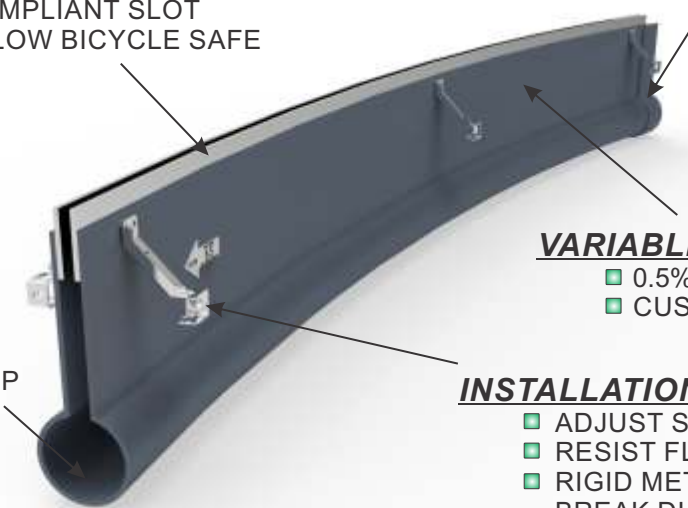

**SMOOTH INTERIOR**

- INCREASED FLOWS
- LESS SEDIMENT BUILD-UP

**VARIABLE HEIGHT RISER**

- 0.5% AND 1% SLOPE STANDARD
- CUSTOM SLOPES OFFERED

**RADIUS SLOT PIPE BODY**

- 8' LENGTHS TYPICAL
- DIAMETERS OF 4", 6", 8", AND 10"
- CUSTOM SLOT AND PIPE WIDTHS

**INSTALLATION DEVICES**

- ADJUST SLOT PIPE TO GRADE
- RESIST FLOTATION FORCES
- RIGID METAL BRACKET WON'T BREAK DURING CONSTRUCTION



**BEFORE**



**AFTER**

# STAINLESS TRENCH (DTSS)

## STANDARD

### SIZES

- 2" ID
- 4" ID
- 6" ID
- 8" ID
- 10" ID
- 12" ID
- 18" ID
- 24" ID



### INSTALLATION

- SHIPS FULLY ASSEMBLED
- PLYWOOD TOP FOR SAFETY
- PLYWOOD KEEPS CONCRETE OUT DURING CONSTRUCTION
- EASILY ATTACH BRACES TO WOOD TOP

### SLOPE

- 0.5% AND 1% SLOPE STANDARD
- CUSTOM SLOPES OFFERED



### CONCRETE ANCHORS

- 18" O.C. TYPICAL
- 3" X 3/8" THICK FOR DURABILITY
- EXTENDS SYSTEM LIFE IN TRAFFIC APPLICATIONS

### INSTALLATION DEVICES

- ADJUST TRENCH TO GRADE
- RESIST FLOTATION FORCES
- RIGID METAL BRACKET WON'T BREAK OFF DURING CONSTRUCTION

### TRENCH BODY

- 8' LENGTHS TYPICAL
- OFFERED IN LENGTHS UP TO 50'
- WIDTHS OF 4", 8", 10", 12", 18", AND 24"
- CUSTOM WIDTHS

## STAINLESS TRENCHES

- OFFERED IN T304 OR T316
- LONG SECTIONS REDUCE JOINTS
- ALL JOINTS HAVE FLANGES THAT CAN BE BOLTED OR WELDED WATER TIGHT
- CLAMPING COLLARS OFFERED FOR MEMBRANE APPLICATIONS
- BUILT IN SLOPE
- WATER TIGHT END PLATES AND OUTLETS
- TAILORED TO CUSTOMER NEEDS





# DTSS2



## SYSTEM CHARACTERISTICS:

- Specialty drain
- Sanitary or Chemical processing applications
- Typical for flows up to 0.3 cfs (150 gpm)
- Light debris loading
- All load classes

MATERIAL	16GA TYP (14GA & 12GA OPTIONAL) T304 TYP (T316 OPTIONAL)
FRAME	INTEGRAL FORMED FRAME
GRATES	3" WIDE GRATES
SYSTEM DEPTH	1.5" - 12" TYP
SECTION LENGTH	8' TYP (SECTIONS UP TO 50' LONG)
SLOPE	0.5% & 1% OR SPECIFY INVERTS

### Engineering Specification:

Trench drain shall be Dura Trench as manufactured by Eric'sons, 574C Industrial Way N., Dallas, GA 30132 - (770-505-6575). The trench drain body shall be constructed from 16ga T304 stainless steel and have a minimum clear opening of 2". Trench invert shall have a rectangular bottom. Sections shall be 96" long (typical), but can be fabricated in longer lengths as required (up to 50' lengths possible) and have a built in slope of 1/8" per foot (typical). The sections shall bolt together via a flange and can be sealed with a gasket or by on site welding. Each of the sections shall be labeled to indicate proper flow and placement. Trench body shall have a class 2b finish standard. Optional mill or bead blast finish as required on the contract documents.

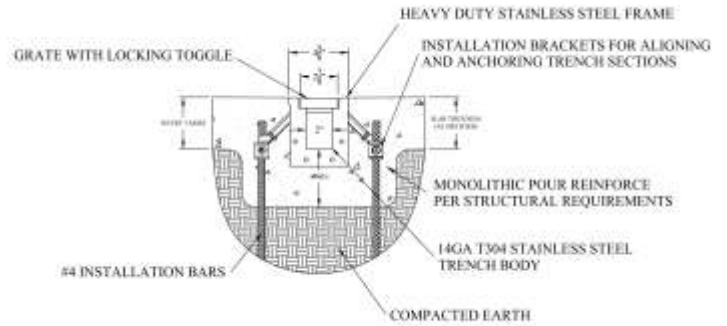

TYPICAL DTSS2 TRENCH SECTION

# DTSSP2



## SYSTEM CHARACTERISTICS:

- Specialty drain
- Sanitary or Chemical processing applications
- Typical for flows up to 0.1 cfs (40 gpm)
- Light debris loading
- All load classes

MATERIAL	16GA TYP (14GA & 12GA OPTIONAL) T304 TYP (T316 OPTIONAL)
FRAME	INTEGRAL FORMED FRAME
GRATES	NA
SYSTEM DEPTH	3" - 24" TYP
SECTION LENGTH	8' TYP (SECTIONS UP TO 50' LONG)
SLOPE	0.5% & 1% OR SPECIFY INVERTS

### Engineering Specification:

Slot drain shall be Dura Trench as manufactured by Eric'sons, 574C Industrial Way N., Dallas, GA 30132 - (770-505-6575). The slot drain body shall be constructed from 16ga T304 stainless steel and have a minimum clear opening of 2.5" I.D. The throat shall have a 3/4" opening. Trench invert shall be V-shaped. Sections shall be 96" long (typical), but can be fabricated in longer lengths as required (up to 50' lengths possible) and have a built in slope of 1/8" per foot (typical). The sections shall bolt together via a flange and can be sealed with a gasket or by on site welding. Each of the sections shall be labeled to indicate proper flow and placement. Trench body shall have a mill finish standard. Optional sand blast finish as required on the contract documents.

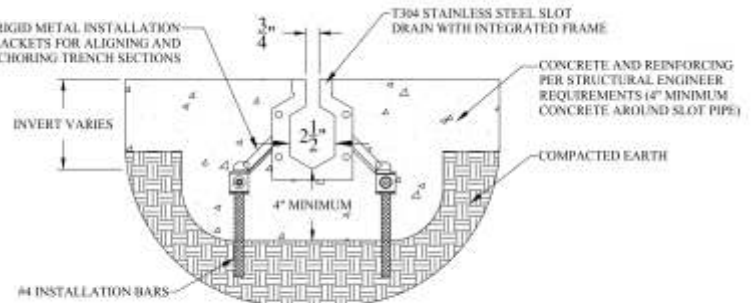

TYPICAL DTSS2 TRENCH SECTION

# DTSS4



## Engineering Specification:

Trench drain shall be Dura Trench as manufactured by Eric'sons, 574C Industrial Way N., Dallas, GA 30132 - (770-505-6575). The trench drain body shall be constructed from 14ga T304 stainless steel and have a minimum clear opening of 4". Trench invert shall be V-shaped or flat bottom as indicated in the plans. Sections shall be 96" long (typical), but can be fabricated in longer lengths as required (up to 50' lengths possible) and have a built in slope of 1/8" per foot (typical). The sections shall bolt together via a flange and can be sealed with a gasket or by on site welding. Each of the sections shall be labeled to indicate proper flow and placement. Trench body shall have a mill finish standard. Optional sand blast finish as required on the contract documents.

## SYSTEM CHARACTERISTICS:

- Specialty drain
- Sanitary or Chemical processing applications
- Typical for flows up to 1.5 cfs (700 gpm)
- Light debris loading
- All load classes

MATERIAL	14GA TYP (16GA & 12GA OPTIONAL) T304 TYP (T316 OPTIONAL)
FRAME	INTEGRAL FORMED FRAME
GRATES	5" WIDE GRATES
SYSTEM DEPTH	2" - 18" TYP
SECTION LENGTH	8' TYP (SECTIONS UP TO 50' LONG)
SLOPE	0.5% & 1% OR SPECIFY INVERTS

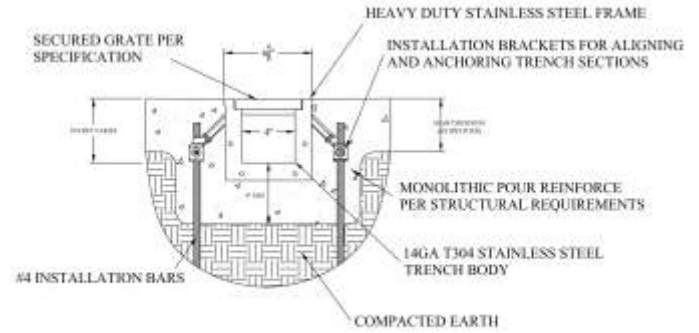

TYPICAL DTSS4 TRENCH SECTION

# DTSSP4



## Engineering Specification:

Slot drain shall be Dura Trench as manufactured by Eric'sons, 574C Industrial Way N., Dallas, GA 30132 - (770-505-6575). The slot drain body shall be constructed from 16ga T304 stainless steel and have a minimum clear opening of 2" I.D. The throat shall have a 3/4" opening. Trench invert shall be V-shaped. Sections shall be 96" long (typical), but can be fabricated in longer lengths as required (up to 50' lengths possible) and have a built in slope of 1/8" per foot (typical). The sections shall bolt together via a flange and can be sealed with a gasket or by on site welding. Each of the sections shall be labeled to indicate proper flow and placement. Trench body shall have a mill finish standard. Optional sand blast finish as required on the contract documents.

## SYSTEM CHARACTERISTICS:

- Specialty drain
- Sanitary or Chemical processing applications
- Typical for flows up to 0.3 cfs (125 gpm)
- Light debris loading
- All load classes

MATERIAL	16GA TYP (14GA & 12GA OPTIONAL) T304 TYP (T316 OPTIONAL)
FRAME	INTEGRAL FORMED FRAME
GRATES	NA
SYSTEM DEPTH	2" - 18" TYP
SECTION LENGTH	8' TYP (SECTIONS UP TO 50' LONG)
SLOPE	0.5% & 1% OR SPECIFY INVERTS

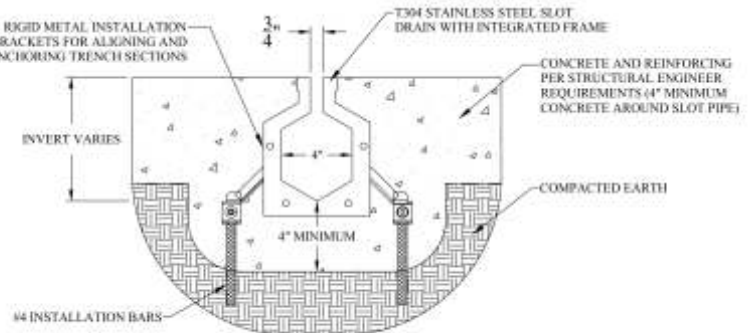

TYPICAL DTSSP4 TRENCH SECTION

# DTSS6



## SYSTEM CHARACTERISTICS:

- Specialty drain
- Sanitary or Chemical processing applications
- Typical for flows up to 3.9 cfs (1750 gpm)
- Moderate debris loading
- All load classes

MATERIAL	14GA TYP (16GA & 12GA OPTIONAL) T304 TYP (T316 OPTIONAL)
FRAME	INTEGRAL FORMED FRAME
GRATES	8" WIDE GRATES
SYSTEM DEPTH	3" - 24" TYP
SECTION LENGTH	8' TYP (SECTIONS UP TO 50' LONG)
SLOPE	0.5% & 1% OR SPECIFY INVERTS

### Engineering Specification:

Trench drain shall be Dura Trench as manufactured by Eric'sons, 574C Industrial Way N., Dallas, GA 30132 - (770-505-6575). The trench drain body shall be constructed from 14ga T304 stainless steel and have a minimum clear opening of 6". Trench invert shall be V-shaped or flat bottom as indicated in the plans. Sections shall be 96" long (typical), but can be fabricated in longer lengths as required (up to 50' lengths possible) and have a built in slope of 1/8" per foot (typical). The sections shall bolt together via a flange and can be sealed with a gasket or by on site welding. Each of the sections shall be labeled to indicate proper flow and placement. Trench body shall have a mill finish standard. Optional sand blast finish as required on the contract documents.

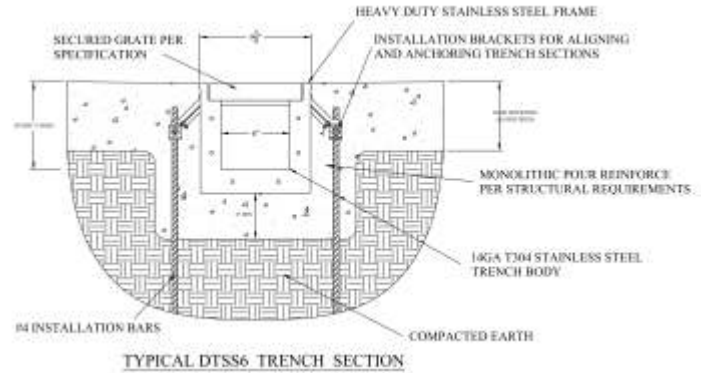

# DTSS8



## SYSTEM CHARACTERISTICS:

- Specialty drain
- Sanitary or Chemical processing applications
- Typical for flows up to 6 cfs (2775 gpm)
- Moderate debris loading
- All load classes

MATERIAL	14GA TYP (16GA & 12GA OPTIONAL) T304 TYP (T316 OPTIONAL)
FRAME	INTEGRAL FORMED FRAME
GRATES	10" WIDE GRATES
SYSTEM DEPTH	3" - 24" TYP
SECTION LENGTH	8' TYP (SECTIONS UP TO 50' LONG)
SLOPE	0.5% & 1% OR SPECIFY INVERTS

### Engineering Specification:

Trench drain shall be Dura Trench as manufactured by Eric'sons, 574C Industrial Way N., Dallas, GA 30132 - (770-505-6575). The trench drain body shall be constructed from 14ga T304 stainless steel and have a minimum clear opening of 8". Trench invert shall be V-shaped or flat bottom as indicated in the plans. Sections shall be 96" long (typical), but can be fabricated in longer lengths as required (up to 50' lengths possible) and have a built in slope of 1/8" per foot (typical). The sections shall bolt together via a flange and can be sealed with a gasket or by on site welding. Each of the sections shall be labeled to indicate proper flow and placement. Trench body shall have a mill finish standard. Optional sand blast finish as required on the contract documents.

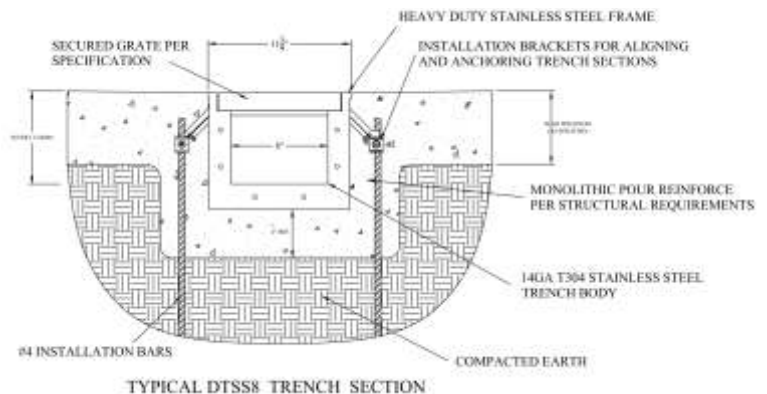



# DTSS10



## Engineering Specification:

Trench drain shall be Dura Trench as manufactured by Eric'sons, 574C Industrial Way N., Dallas, GA 30132 - (770-505-6575). The trench drain body shall be constructed from 14ga T304 stainless steel and have a minimum clear opening of 10". Trench invert shall be V-shaped or flat bottom as indicated in the plans. Sections shall be 96" long (typical), but can be fabricated in longer lengths as required (up to 50' lengths possible) and have a built in slope of 1/8" per foot (typical). The sections shall bolt together via a flange and can be sealed with a gasket or by on site welding. Each of the sections shall be labeled to indicate proper flow and placement. Trench body shall have a mill finish standard. Optional sand blast finish as required on the contract documents.

## SYSTEM CHARACTERISTICS:

- Specialty drain
- Sanitary or Chemical processing applications
- Typical for flows up to 8.8 cfs (3900 gpm)
- Moderate debris loading
- All load classes

MATERIAL	14GA TYP (16GA & 12GA OPTIONAL) T304 TYP (T316 OPTIONAL)
FRAME	INTEGRAL FORMED FRAME
GRATES	12" WIDE GRATES
SYSTEM DEPTH	3" - 24" TYP
SECTION LENGTH	8' TYP (SECTIONS UP TO 50' LONG)
SLOPE	0.5% & 1% OR SPECIFY INVERTS

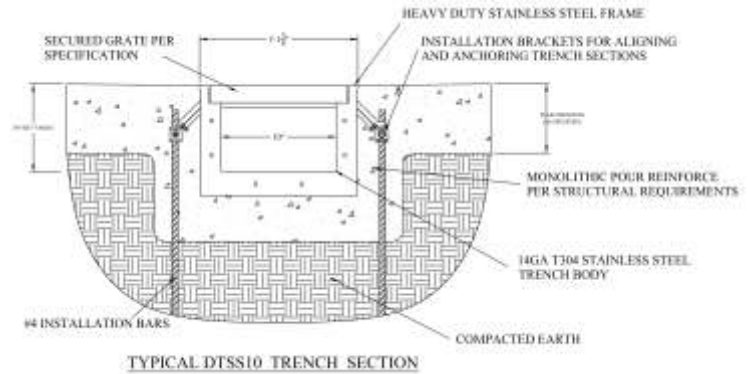

# DTSS12



## Engineering Specification:

Trench drain shall be Dura Trench as manufactured by Eric'sons, 574C Industrial Way N., Dallas, GA 30132 - (770-505-6575). The trench drain body shall be constructed from 14ga T304 stainless steel and have a minimum clear opening of 12". Trench invert shall be V-shaped or flat bottom as indicated in the plans. Sections shall be 96" long (typical), but can be fabricated in longer lengths as required (up to 50' lengths possible) and have a built in slope of 1/8" per foot (typical). The sections shall bolt together via a flange and can be sealed with a gasket or by on site welding. Each of the sections shall be labeled to indicate proper flow and placement. Trench body shall have a mill finish standard. Optional sand blast finish as required on the contract documents.

## SYSTEM CHARACTERISTICS:

- Specialty drain
- Sanitary or Chemical processing applications
- Typical for flows up to 11.8 cfs (5275 gpm)
- Heavy debris loading
- All load classes

MATERIAL	14GA TYP (16GA & 12GA OPTIONAL) T304 TYP (T316 OPTIONAL)
FRAME	INTEGRAL FORMED FRAME
GRATES	14" WIDE GRATES
SYSTEM DEPTH	3" - 24" TYP
SECTION LENGTH	8' TYP (SECTIONS UP TO 50' LONG)
SLOPE	0.5% & 1% OR SPECIFY INVERTS

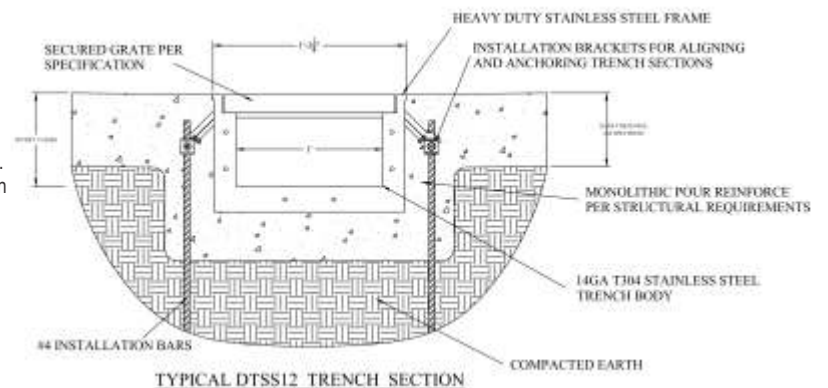

# DTSS18



## SYSTEM CHARACTERISTICS:

- Specialty drain
- Sanitary or Chemical processing applications
- Typical for flows up to 15.0 cfs (6725 gpm)
- Heavy debris loading
- All load classes

MATERIAL	14GA TYP (16GA & 12GA OPTIONAL) T304 TYP (T316 OPTIONAL)
FRAME	INTEGRAL FORMED FRAME
GRATES	20" WIDE GRATES
SYSTEM DEPTH	3" - 18" TYP
SECTION LENGTH	8' TYP (SECTIONS UP TO 50' LONG)
SLOPE	0.5% & 1% OR SPECIFY INVERTS

## Engineering Specification:

Trench drain shall be Dura Trench as manufactured by Eric'sons, 574C Industrial Way N., Dallas, GA 30132 - (770-505-6575). The trench drain body shall be constructed from 14ga T304 stainless steel and have a minimum clear opening of 18". Trench invert shall be V-shaped or flat bottom as indicated in the plans. Sections shall be 96" long (typical), but can be fabricated in longer lengths as required (up to 50' lengths possible) and have a built in slope of 1/8" per foot (typical). The sections shall bolt together via a flange and can be sealed with a gasket or by on site welding. Each of the sections shall be labeled to indicate proper flow and placement. Trench body shall have a mill finish standard. Optional sand blast finish as required on the contract documents.

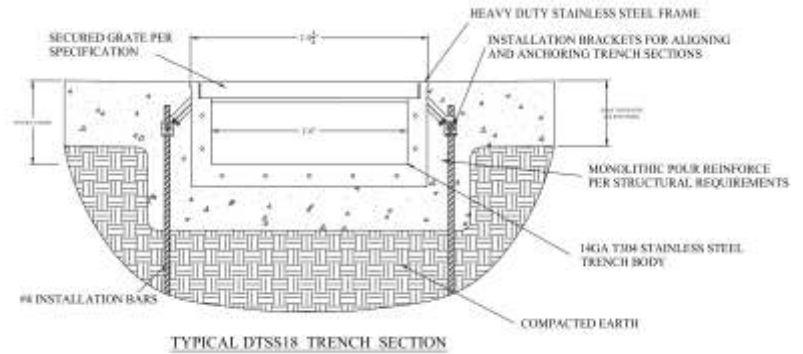

# DTSS24



## SYSTEM CHARACTERISTICS:

- Specialty drain
- Sanitary or Chemical processing applications
- Typical for flows up to 22.6 cfs (10,150 gpm)
- Heavy debris loading
- All load classes

MATERIAL	14GA TYP (16GA & 12GA OPTIONAL) T304 TYP (T316 OPTIONAL)
FRAME	INTEGRAL FORMED FRAME
GRATES	26" WIDE GRATES
SYSTEM DEPTH	3" - 18" TYP
SECTION LENGTH	8' TYP (SECTIONS UP TO 50' LONG)
SLOPE	0.5% & 1% OR SPECIFY INVERTS

## Engineering Specification:

Trench drain shall be Dura Trench as manufactured by Eric'sons, 574C Industrial Way N., Dallas, GA 30132 - (770-505-6575). The trench drain body shall be constructed from 14ga T304 stainless steel and have a minimum clear opening of 24". Trench invert shall be V-shaped or flat bottom as indicated in the plans. Sections shall be 96" long (typical), but can be fabricated in longer lengths as required (up to 50' lengths possible) and have a built in slope of 1/8" per foot (typical). The sections shall bolt together via a flange and can be sealed with a gasket or by on site welding. Each of the sections shall be labeled to indicate proper flow and placement. Trench body shall have a mill finish standard. Optional sand blast finish as required on the contract documents.

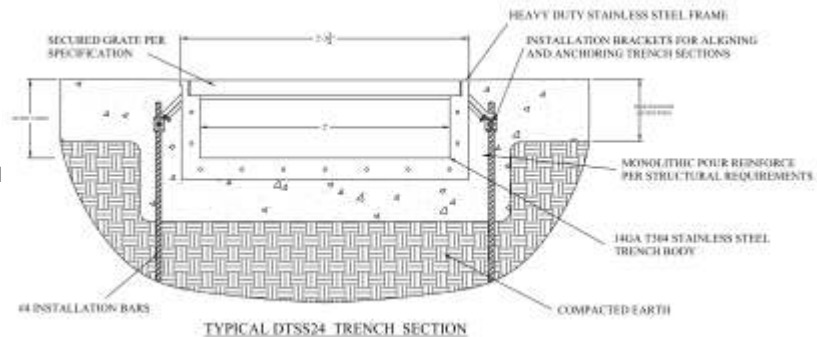

# CHEMICAL TRENCH BODIES (DTCF)

## STANDARD

### SIZES

2" ID

4" ID

6" ID

8" ID

10" ID

12" ID

18" ID

24" ID

36" ID

48" ID



### SLOPE

- 1% MINIMUM SLOPE RECOMMENDED
- CUSTOM SLOPES OFFERED

### LOAD BEARING FRAME

- ANY LOAD CONDITION
- MATERIAL OPTIONS INCLUDE:
  - POWDER COATED STEEL
  - GALVANIZED STEEL
  - ALUMINUM
  - PLASTIC
  - FIBERGLASS
  - STAINLESS STEEL
- FACTORY ATTACHED TO BODY



### TRENCH BODY

- 8' OR 16' LENGTHS TYPICAL
- SINGLE OR DOUBLE CONTAINED BODY
- WIDTHS FROM 2" - 48" STANDARD
- VINYL ESTER OR NOVALAK RESIN SYSTEMS



**Dura Trench**  
manufactured by Eric'son  
**CHEM DRAINS**

The Dura-Trench line of chemical trenches are very similar to the standard DTPF trenches. With all the same features and benefits, they are the easiest trenches to install on the market and with the right chemical composition they are very resistant to most harsh chemicals even at elevated temperatures. With harsh chemicals the SLCF joint bonding kit should be used. Particular attention needs to be paid to ensure a water tight system. It is best to water test these systems before concrete is placed around them to ensure a complete seal. It is also recommended that a significant reinforcing cage be installed around chemical trenches to minimize large movements in the concrete which can cause cracks and leaking of the trench drain system.



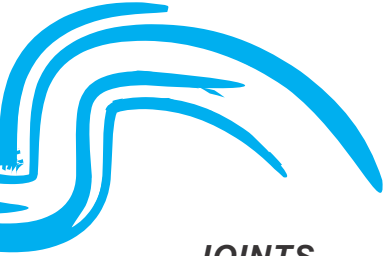

### **JOINTS**

- 2" BELL CONNECTIONS SHOULD BE SEALED WATER TIGHT
- USE CHEMICAL RESISTANT BONDING KITS (SLCF)



### **CONCRETE ANCHORS**

- 18" O.C. TYPICAL
- 3" X 3/8" THICK FOR DURABILITY
- EXTENDED SYSTEM LIFE IN TRAFFIC APPLICATIONS

### **INSTALLATION DEVICES**

- ADJUST TRENCH TO GRADE
- RESIST FLOTATION FORCES
- RIGID METAL BRACKET WON'T BREAK OFF DURING CONSTRUCTION

### **PREFABRICATED TURNS**

- SMOOTH INTERIOR
- CONTRACTOR FRIENDLY
- WELDED FRAME



## **CHEMICAL TRENCHES**

- OFFERED WITH VINYL ESTER OR NOVALAK RESIN BODIES
- LONG SECTIONS REDUCE JOINTS
- ALL JOINTS ARE SEALABLE TO WATER TIGHT CONDITIONS
- CLAMPING COLLARS OFFERED FOR MEMBRANE APPLICATIONS
- BUILT IN SLOPE
- WATER TIGHT END PLATES AND OUTLETS
- TAILORED TO CUSTOMER NEEDS



Chemical trenches are available with 100% composite construction with no metal components. With certain chemical combinations even stainless steel materials can be compromised. In these applications a 100% polymer trench can be a viable solution.

Don't be fooled by the composite construction. These trenches can be designed to take fork truck traffic and handle the most harsh production environments.

# MEMBRANE & SHOWER DRAINS (DTSH)

## GRATES

- ACCEPTS ALL STANDARD GRATE
- CUSTOM ORNAMENTAL PATTERNS ARE COMMONLY UTILIZED FOR THESE SYSTEMS

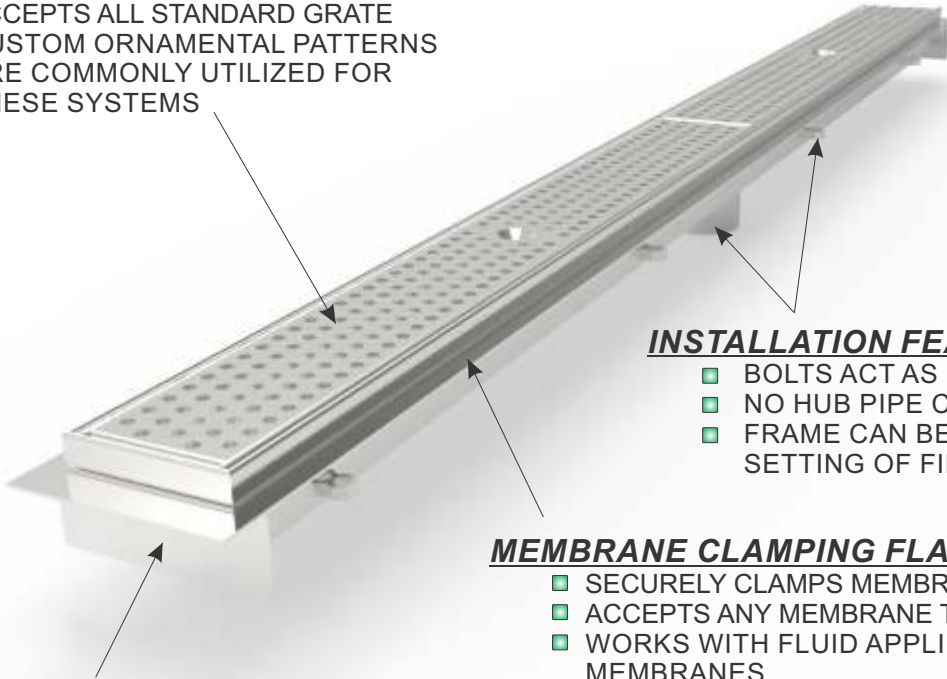

## INSTALLATION FEATURES

- BOLTS ACT AS FEET TO LEVEL DRAIN
- NO HUB PIPE CONNECTIONS
- FRAME CAN BE LEVELED DURING SETTING OF FINAL TILE/PAVEMENT

## MEMBRANE CLAMPING FLANGE

- SECURELY CLAMPS MEMBRANE
- ACCEPTS ANY MEMBRANE THICKNESS
- WORKS WITH FLUID APPLIED MEMBRANES

## TRENCH BODY

- SEAMLESS T304 STAINLESS (316 OPTIONAL)
- OFFERED IN LENGTHS UP TO 50'
- WIDTHS OF 2", 4", 8", 10", 12", 18", AND 24"



This elevated deck is a typical application that might require a shallow membrane drain placed in the topping slab. This drain was 8" wide inside with a 10" wide heel proof slotted stainless steel grate.



**Dura Trench**  
manufactured by Eric'sons  
**MEMBRANE  
DRAINS**

Linear shower drains are becoming more and more common in health care, hospitality, and residential applications. Some utilize very decorative grates while others prefer something simple. We can manufacture these in standard lengths or any custom width desired.

### MEMBRANE DRAINS

- DEPTHS CAN BE AS SHALLOW AS 2"
- LONG SECTIONS REDUCE JOINTS
- ALL JOINTS ARE SEALABLE TO WATER TIGHT CONDITIONS
- CLAMPING COLLARS STANDARD FOR SECURING MEMBRANE
- BUILT IN SLOPE OFFERED
- WATER TIGHT END PLATES AND OUTLETS
- CUSTOMIZABLE

Custom grating patterns are often requested for terrace and elevated deck applications. This project required T316 stainless steel for superior corrosion resistance and utilized a diagonal wave pattern.





# TRENCH FORMING SYSTEMS (DTTF)

## STANDARD SIZES

- 8" ID
- 10" ID
- 12" ID
- 18" ID
- 24" ID



## TRENCH BODY

- 8' LENGTHS TYPICAL
- OPTIONAL 16', LENGTHS
- SINGLE USE OR REUSABLE FORMS OFFERED
- WIDTHS OF 8", 10", 12", 18", 24"
- CUSTOM WIDTHS

## TRENCH FORMING SYSTEMS

- EXTREMELY FAST COMPARED WITH HAND FORMING
- MULTIPLE FORMING MATERIALS CAN MEET ANY DESIGN PARAMETERS
- RADIUS BOTTOMS
- BUILT IN SLOPE
- FITS ALL STANDARD FRAMES AND GRATES ANY WIDTH TRENCH
- GREEN - DISPOSE OF LESS FORMING MATERIAL
- EASY INSTALLATION

## SLOPE

- 0.5% AND 1% SLOPE STANDARD
- CUSTOM SLOPES OFFERED

## RADIUS INTERIOR

- INCREASED FLOW
- LESS SEDIMENT BUILD-UP



The Dura-Trench forming system is a single use or reusable set of trench drain forms used to construct cast in place trench drains. Once the form work is removed the concrete trench has a radius bottom which is difficult to achieve with job built forms. The system also has single use forms that can be used for special fabrications such as turns, intersections, or end points that are not a standard length. Because of the rigidity of the forming system they are easy to bolt together and gang form repetitive trench drain layouts. The rigid forms also strip much easier than other methods and eliminate the need for discarding dumpster after dumpster of forming debris. As with all the Dura-Trench systems, a wide array of frame and grate options are offered with this system.

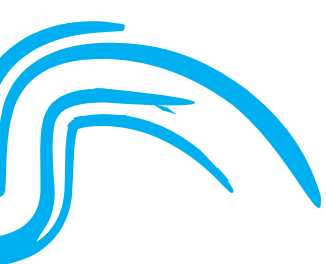

**LOAD BEARING FRAME**

- ANY LOAD CONDITION
- MATERIAL OPTIONS INCLUDE:
  - POWDER COATED STEEL
  - GALVANIZED STEEL
  - IRON
  - ALUMINUM
  - PLASTIC
  - FIBERGLASS
  - STAINLESS STEEL

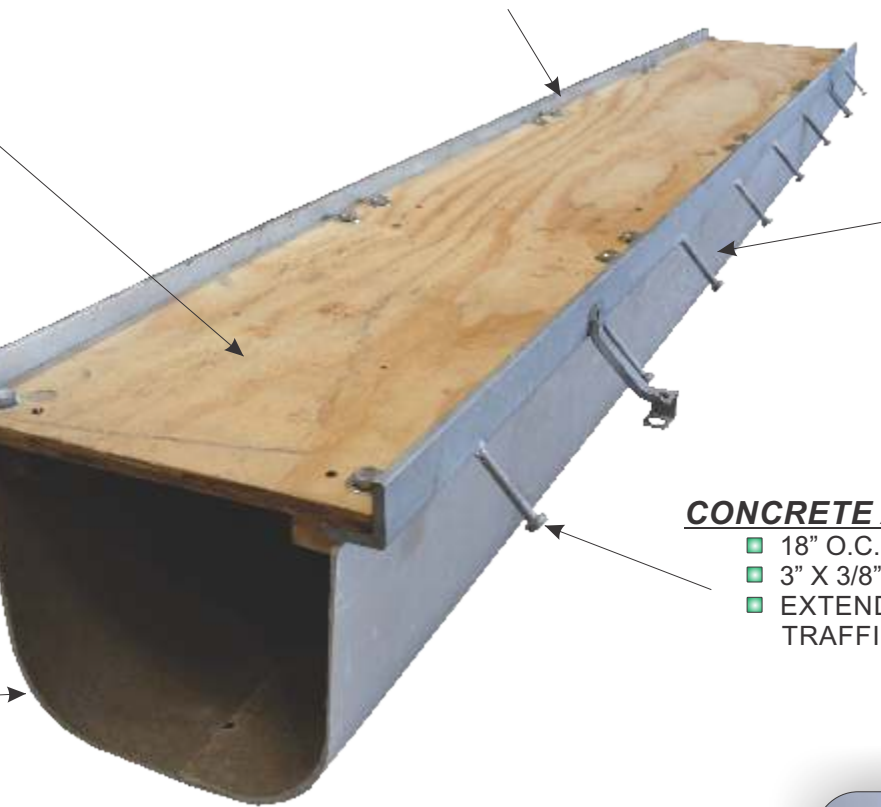

**INSTALLATION**

- SINGLE USE OR REUSABLE FORMS
- PLYWOOD OR METAL COVERS FOR SAFETY
- COVERS KEEP CONCRETE OUT DURING CONSTRUCTION
- EASILY ATTACH BRACES TO WOOD TOP

**CONCRETE ANCHORS**

- 18" O.C. TYPICAL
- 3" X 3/8" THICK FOR DURABILITY
- EXTENDS SYSTEM LIFE IN TRAFFIC APPLICATIONS

**GRATES**

- WIDE VARIETY OF GRATES
- PEDESTRIAN TO AIRCRAFT LOADING
- ADA & HEEL PROOF OPTIONS

**NOTES:**

1. Maximum length is only limited by constructability.
2. Standard slope is 1% unless specified otherwise.
3. Rectangular bottom trenches are available upon request or per application.



# DTTF8



\*shown here with the EXGS frame

## SYSTEM CHARACTERISTICS:

- General Purpose Drain
- Typical for flows up to 4 cfs (1800 gpm)
- Moderate debris loading
- All load classes

FRAME OPTIONS	MDGS, MDSS, MDAL, HDBP, HDGS, HDSS, HDFG, EXGS, EXSS, EXDI, CUSTOM
GRATES	10" WIDE GRATES
SYSTEM DEPTH	6" - 48" TYP (3" MIN DEPTH WITH RECT BOTTOM)
SECTION LENGTH	8' TYP (16' OPTION)
SLOPE	0.5% & 1% OR SPECIFY INVERTS

## Engineering Specification:

Trench drain shall be DuraTrench as manufactured by Eric'sons, 574C Industrial Way N., Dallas, GA 30132 - (770-505-6575). The trench drain body shall be a concrete trench cast on pre-engineered factory fabricated form pannels. The trench shall have a 8" clear open throat and have a rounded or flat bottom as indicated in details. Form sections shall be 96" long (typical) and shall be labeled for proper slope and placement. The trench body shall mate to the frame and form a grate seat that shall accept the specified grate. The body shall be supplied with a factory fit top for rail alignment and fastening of the channels in the field ensuring that the rails are cast in a coplanar manner. Form release is to be used liberally to ensure smooth interior walls and easy for removal. No forming materials shall be left in the trench after construction. Inspection of the underlying concrete shall be performed and any deficiencies shall be repaired according to standard ACI guidelines.

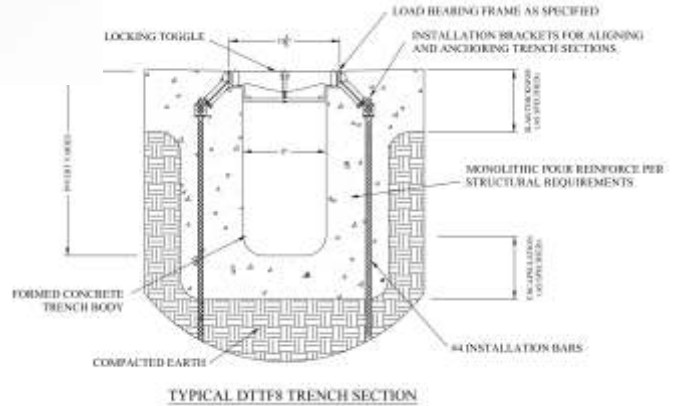

# DTTF10



\*shown here with the EXGS frame

## SYSTEM CHARACTERISTICS:

- General Purpose Drain
- Typical for flows up to 6 cfs (2700 gpm)
- Moderate debris loading
- All load classes

FRAME OPTIONS	MDGS, MDSS, MDAL, HDBP, HDGS, HDSS, HDFG, EXGS, EXSS, EXDI, CUSTOM
GRATES	12" WIDE GRATES
SYSTEM DEPTH	6" - 48" TYP (3" MIN DEPTH WITH RECT BOTTOM)
SECTION LENGTH	8' TYP (16' OPTION)
SLOPE	0.5% & 1% OR SPECIFY INVERTS

## Engineering Specification:

Trench drain shall be DuraTrench as manufactured by Eric'sons, 574C Industrial Way N., Dallas, GA 30132 - (770-505-6575). The trench drain body shall be a concrete trench cast on pre-engineered factory fabricated form pannels. The trench shall have a 10" clear open throat and have a rounded or flat bottom as indicated in details. Form sections shall be 96" long (typical) and shall be labeled for proper slope and placement. The trench body shall mate to the frame and form a grate seat that shall accept the specified grate. The body shall be supplied with a factory fit top for rail alignment and fastening of the channels in the field ensuring that the rails are cast in a coplanar manner. Form release is to be used liberally to ensure smooth interior walls and easy for removal. No forming materials shall be left in the trench after construction. Inspection of the underlying concrete shall be performed and any deficiencies shall be repaired according to standard ACI guidelines.

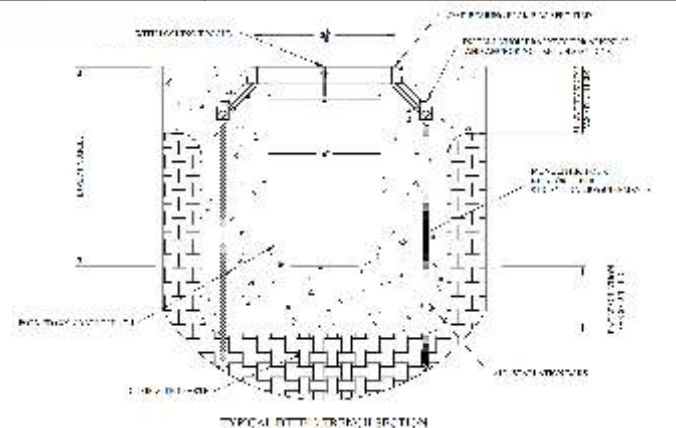



# DTTF12



\*shown here with the EXGS frame

## SYSTEM CHARACTERISTICS:

- General Purpose Drain
- Typical for flows up to 8 cfs (3600 gpm)
- Heavy debris loading
- All load classes

FRAME OPTIONS	MDGS, MDSS, MDAL, HDBP, HDGS, HDSS, HDFG, EXGS, EXSS, EXDI, CUSTOM
GRATES	14" WIDE GRATES
SYSTEM DEPTH	6" - 48" TYP (3" MIN DEPTH WITH RECT BOTTOM)
SECTION LENGTH	8' TYP (16' OPTION)
SLOPE	0.5% & 1% OR SPECIFY INVERTS

## Engineering Specification:

Trench drain shall be DuraTrench as manufactured by Eric'sons, 574C Industrial Way N., Dallas, GA 30132 - (770-505-6575). The trench drain body shall be a concrete trench cast on pre-engineered factory fabricated form panels. The trench shall have a 12" clear open throat and have a rounded or flat bottom as indicated in details. Form sections shall be 96" long (typical) and shall be labeled for proper slope and placement. The trench body shall mate to the frame and form a grate seat that shall accept the specified grate. The body shall be supplied with a factory fit top for rail alignment and fastening of the channels in the field ensuring that the rails are cast in a coplanar manner. Form release is to be used liberally to ensure smooth interior walls and easy for removal. No forming materials shall be left in the trench after construction. Inspection of the underlying concrete shall be performed and any deficiencies shall be repaired according to standard ACI guidelines.

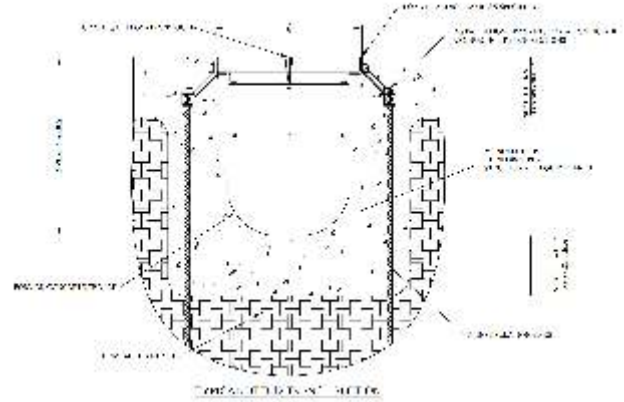

# DTTF18



\*shown here with the EXGS frame

## SYSTEM CHARACTERISTICS:

- General Purpose Drain
- Typical for flows up to 15 cfs (6750 gpm)
- Heavy debris loading
- All load classes

FRAME OPTIONS	MDGS, MDSS, MDAL, HDBP, HDGS, HDSS, HDFG, EXGS, EXSS, EXDI, CUSTOM
GRATES	20" WIDE GRATES
SYSTEM DEPTH	6" - 48" TYP (3" MIN DEPTH WITH RECT BOTTOM)
SECTION LENGTH	8' TYP (16' OPTION)
SLOPE	0.5% & 1% OR SPECIFY INVERTS

## Engineering Specification:

Trench drain shall be DuraTrench as manufactured by Eric'sons, 574C Industrial Way N., Dallas, GA 30132 - (770-505-6575). The trench drain body shall be a concrete trench cast on pre-engineered factory fabricated form panels. The trench shall have a 18" clear open throat and have a rounded or flat bottom as indicated in details. Form sections shall be 96" long (typical) and shall be labeled for proper slope and placement. The trench body shall mate to the frame and form a grate seat that shall accept the specified grate. The body shall be supplied with a factory fit top for rail alignment and fastening of the channels in the field ensuring that the rails are cast in a coplanar manner. Form release is to be used liberally to ensure smooth interior walls and easy for removal. No forming materials shall be left in the trench after construction. Inspection of the underlying concrete shall be performed and any deficiencies shall be repaired according to standard ACI guidelines.

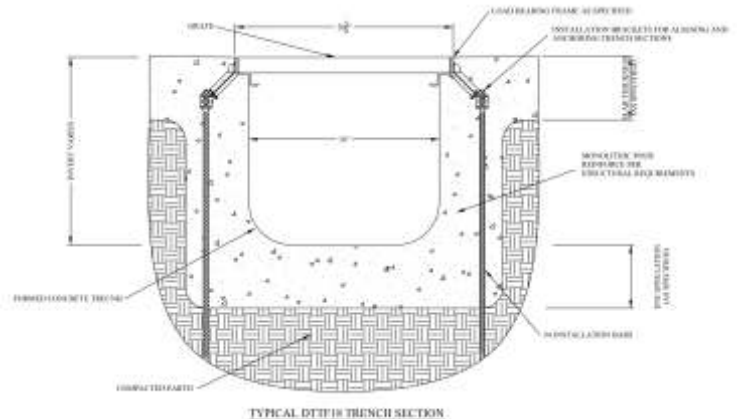

# DTTF24



\*shown here with the EXGS frame

## SYSTEM CHARACTERISTICS:

- General Purpose Drain
- Typical for flows up to 23 cfs (10,350 gpm)
- Heavy debris loading
- All load classes

FRAME OPTIONS	MDGS, MDSS, MDAL, HDBP, HDGS, HDSS, HDFG, EXGS, EXSS, EXDI, CUSTOM
GRATES	26" WIDE GRATES
SYSTEM DEPTH	6" - 48" TYP (3" MIN DEPTH WITH RECT BOTTOM)
SECTION LENGTH	8' TYP (16' OPTION)
SLOPE	0.5% & 1% OR SPECIFY INVERTS

## Engineering Specification:

Trench drain shall be DuraTrench as manufactured by Eric'sons, 574C Industrial Way N., Dallas, GA 30132 - (770-505-6575). The trench drain body shall be a concrete trench cast on pre-engineered factory fabricated form pannels. The trench shall have a 24" clear open throat and have a rounded or flat bottom as indicated in details. Form sections shall be 96" long (typical) and shall be labeled for proper slope and placement. The trench body shall mate to the frame and form a grate seat that shall accept the specified grate. The body shall be supplied with a factory fit top for rail alignment and fastening of the channels in the field ensuring that the rails are cast in a coplanar manner. Form release is to be used liberally to ensure smooth interior walls and easy for removal. No forming materials shall be left in the trench after construction. Inspection of the underlying concrete shall be performed and any deficiencies shall be repaired according to standard ACI guidelines.

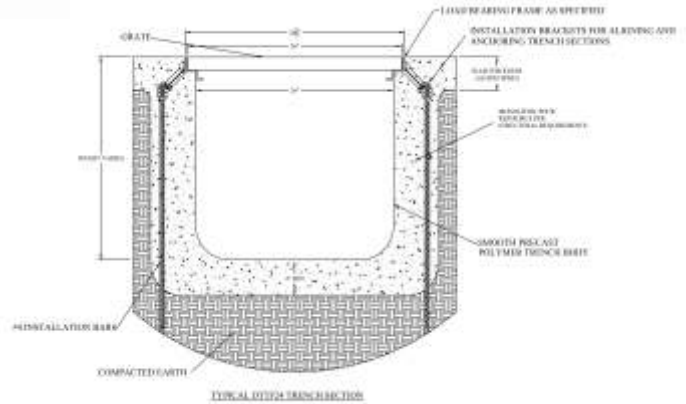

**NOTE: FORMING SYSTEMS WIDER THAN 24" ARE NOT RECOMMENDED**







Concrete formed trenches are generally more expensive to construct due to the lack of skilled labor and wage rates. With the Dura Trench prefabricated forming system much of this labor and skill is removed. The end results look basically the same as a prefabricated trench from the surface, but in some instances are preferred to a prefabricated trench. No matter what system you need, Dura Trench has a solution for your linear drain needs.



**Dura Trench**  
manufactured by Eric'sons



# UTILITY TRENCHES (DTUTPF)

## STANDARD SIZES

- 8" ID
- 10" ID
- 12" ID
- 18" ID
- 24" ID
- 36" ID
- 48" ID



## UTILITY TRENCHES

- USE TO RUN CABLES AND PIPES
- NO CROSS BARS FOR EASY INSTALLATION AND ACCESS
- TYPICAL TRENCH WIDTHS ARE 8", 10", 12", 18", 24", 36", AND 48".
- TRENCH CAN BE SLOPED OR NEUTRAL
- WIDE VARIETY OF COVERS AVAILABLE (OPTIONS INCLUDE ALUMINUM, FIBERGLASS, GALV. STEEL, STAINLESS STEEL, AND DUCTILE IRON)
- FACTORY FABRICATED TURNS AND INTERSECTIONS
- JOINTS CAN BE SEALED WATERTIGHT FOR SECONDARY CONTAINMENT
- FACT



**APPLICATIONS:**  
CHEMICAL PIPING  
COMPRESSED AIR PIPING  
VACUUM HOSE TRENCHES  
FIRE SUPPRESSION PIPING  
ELECTRICAL CABLES  
GAS PIPING  
FUEL LINES

ORY



Utility trenches are vital for inspection and access of piping and cables. The Dura-Trench DTUTPF system makes the construction of these trenches easy. The systems can be sloped for drainage or specified with no slope. Options like gasketed covers, sweep turns, open grating covers, leak detection, prefabricated turns, step up/down fabrications, and sealed joints make this system a real workhorse for those difficult applications. These trenches can be fabricated from vinyl ester resin where secondary containment of concentrated chemicals is required.

All of these systems come standard with galvanized, stainless, or composite channel struts inside of the trenches. This aides in installation of conduits and pipes. Large sweeping turns can also allow for large pipe diameters to be installed in the system.





**Dura Trench**  
manufactured by Eric'sons



# DTUTPF10



\*shown here with the HDBP frame

## Engineering Specification:

Utility trench shall be DuraTrench as manufactured by Eric'sons, 574C Industrial Way N., Dallas, GA 30132 - (770-505-6575). The utility trench body shall act as secondary containment and be composed of polyester fiber reinforced polymer concrete. The trench shall have a 10" clear open throat and have a rectangular bottom. The trench body shall be gray in color to closely resemble the color of concrete. Sections shall be 96" long (typical) and have a 2" receiving flange on the upstream end for receiving and sealing the trench sections together. Each of the sections shall be labeled to indicate proper placement. The trench body shall mate to the frame and form a grate seat that shall accept the specified cover. The body shall be supplied with a factory fit protective top for rail alignment and fastening of the channels in the field ensuring that the rails are cast in a coplanar manner. The trench shall not have any cross bars that will interfere with later installation of utilities in the trench. The trench shall have 1 5/8" x 1 5/8" galvanized strut channel cast into the trench walls for mounting of utilities. The strut shall have 3" x 3/8" dia. concrete anchors locking the strut into the surrounding concrete once cast. The trench body shall have the following properties: 12,600 psi minimum tensile strength per ASTM C307, 11,600 psi. minimum compressive strength per ASTM C579, 26,500 psi minimum flexural strength per ASTM C580, less than 0.35% water absorption, shall be frost proof, salt proof, and be resistant to dilute acids and alkalis per ASTM C267.

## SYSTEM CHARACTERISTICS:

- Secondary containment utility trench
- Built in 1 5/8" channel strut (48" o.c. typ)
- No internal cross braces to obstruct pipe installation
- Significantly increases speed of installation
- All load classes

FRAME OPTIONS	MDGS, MDSS, MDAL, HDBP, HDGS, HDSS, HDFG, EXGS, EXSS, EXDI, CUSTOM
GRATES	12" WIDE COVERS (OPTIONAL GASKETS)
SYSTEM DEPTH	12" - 36" TYP
SECTION LENGTH	8' TYP (16' OPTION)
SLOPE	0.0%, 0.5% & 1% OR SPECIFY INVERTS

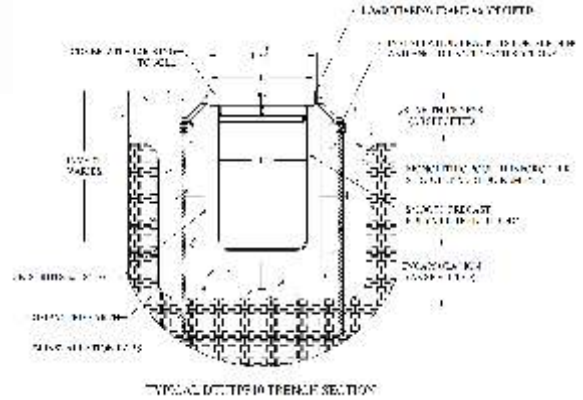

# DTUTPF12



\*shown here with the HDBP frame

## Engineering Specification:

Utility trench shall be DuraTrench as manufactured by Eric'sons, 574C Industrial Way N., Dallas, GA 30132 - (770-505-6575). The utility trench body shall act as secondary containment and be composed of polyester fiber reinforced polymer concrete. The trench shall have a 12" clear open throat and have a rectangular bottom. The trench body shall be gray in color to closely resemble the color of concrete. Sections shall be 96" long (typical) and have a 2" receiving flange on the upstream end for receiving and sealing the trench sections together. Each of the sections shall be labeled to indicate proper placement. The trench body shall mate to the frame and form a grate seat that shall accept the specified cover. The body shall be supplied with a factory fit protective top for rail alignment and fastening of the channels in the field ensuring that the rails are cast in a coplanar manner. The trench shall not have any cross bars that will interfere with later installation of utilities in the trench. The trench shall have 1 5/8" x 1 5/8" galvanized strut channel cast into the trench walls for mounting of utilities. The strut shall have 3" x 3/8" dia. concrete anchors locking the strut into the surrounding concrete once cast. The trench body shall have the following properties: 12,600 psi minimum tensile strength per ASTM C307, 11,600 psi. minimum compressive strength per ASTM C579, 26,500 psi minimum flexural strength per ASTM C580, less than 0.35% water absorption, shall be frost proof, salt proof, and be resistant to dilute acids and alkalis per ASTM C267.

## SYSTEM CHARACTERISTICS:

- Secondary containment utility trench
- Built in 1 5/8" channel strut (48" o.c. typ)
- No internal cross braces to obstruct pipe installation
- Significantly increases speed of installation
- All load classes

FRAME OPTIONS	MDGS, MDSS, MDAL, HDBP, HDGS, HDSS, HDFG, EXGS, EXSS, EXDI, CUSTOM
GRATES	14" WIDE COVERS (OPTIONAL GASKETS)
SYSTEM DEPTH	12" - 36" TYP
SECTION LENGTH	8' TYP (16' OPTION)
SLOPE	0.0%, 0.5% & 1% OR SPECIFY INVERTS

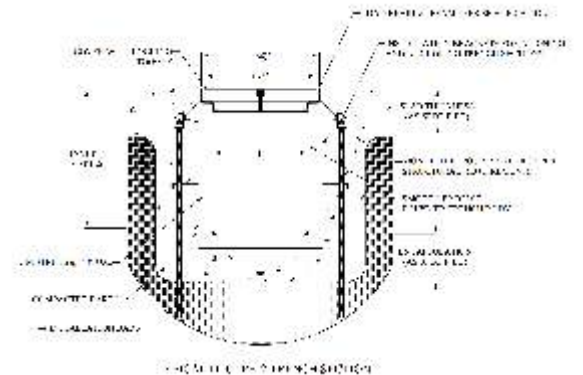



# DTUTPF18



\*shown here with the HDBP frame

## SYSTEM CHARACTERISTICS:

- Secondary containment utility trench
- Built in 1 5/8" channel strut (48" o.c. typ)
- No internal cross braces to obstruct pipe installation
- Significantly increases speed of installation
- All load classes

FRAME OPTIONS	MDGS, MDSS, MDAL, HDBP, HDGS, HDSS, HDFG, EXGS, EXSS, EXDI, CUSTOM
GRATES	20" WIDE COVERS (OPTIONAL GASKETS)
SYSTEM DEPTH	12" - 36" TYP
SECTION LENGTH	8' TYP (16' OPTION)
SLOPE	0.0%, 0.5% & 1% OR SPECIFY INVERTS

## Engineering Specification:

Utility trench shall be DuraTrench as manufactured by Eric'sons, 574C Industrial Way N., Dallas, GA 30132 - (770-505-6575). The utility trench body shall act as secondary containment and be composed of polyester fiber reinforced polymer concrete. The trench shall have a 18" clear open throat and have a rectangular bottom. The trench body shall be gray in color to closely resemble the color of concrete. Sections shall be 96" long (typical) and have a 2" receiving flange on the upstream end for receiving and sealing the trench sections together. Each of the sections shall be labeled to indicate proper placement. The trench body shall mate to the frame and form a grate seat that shall accept the specified cover. The body shall be supplied with a factory fit protective top for rail alignment and fastening of the channels in the field ensuring that the rails are cast in a coplanar manner. The trench shall not have any cross bars that will interfere with later installation of utilities in the trench. The trench shall have 1 5/8" x 1 5/8" galvanized strut channel cast into the trench walls for mounting of utilities. The strut shall have 3" x 3/8" dia. concrete anchors locking the strut into the surrounding concrete once cast. The trench body shall have the following properties: 12,600 psi minimum tensile strength per ASTM C307, 11,600 psi. minimum compressive strength per ASTM C579, 26,500 psi minimum flexural strength per ASTM C580, less than 0.35% water absorption, shall be frost proof, salt proof, and be resistant to dilute acids and alkalis per ASTM C267.

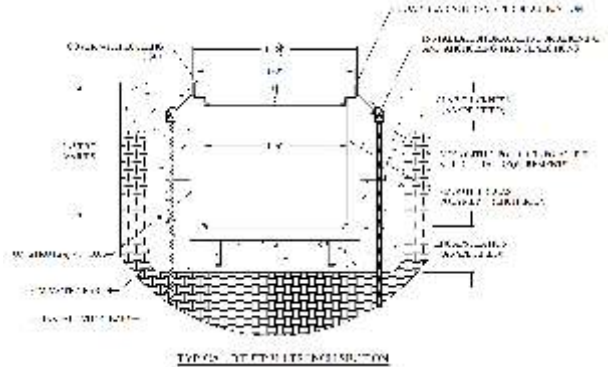

# DTUTPF24



\*shown here with the HDGS frame and 24" O.C. channel strut option

## SYSTEM CHARACTERISTICS:

- Secondary containment utility trench
- Built in 1 5/8" channel strut (48" o.c. typ)
- No internal cross braces to obstruct pipe installation
- Significantly increases speed of installation
- All load classes

FRAME OPTIONS	MDGS, MDSS, MDAL, HDBP, HDGS, HDSS, HDFG, EXGS, EXSS, EXDI, CUSTOM
GRATES	26" WIDE COVERS (OPTIONAL GASKETS)
SYSTEM DEPTH	12" - 36" TYP
SECTION LENGTH	8' TYP (16' OPTION)
SLOPE	0.0%, 0.5% & 1% OR SPECIFY INVERTS

## Engineering Specification:

Utility trench shall be DuraTrench as manufactured by Eric'sons, 574C Industrial Way N., Dallas, GA 30132 - (770-505-6575). The utility trench body shall act as secondary containment and be composed of polyester fiber reinforced polymer concrete. The trench shall have a 24" clear open throat and have a rectangular bottom. The trench body shall be gray in color to closely resemble the color of concrete. Sections shall be 96" long (typical) and have a 2" receiving flange on the upstream end for receiving and sealing the trench sections together. Each of the sections shall be labeled to indicate proper placement. The trench body shall mate to the frame and form a grate seat that shall accept the specified cover. The body shall be supplied with a factory fit protective top for rail alignment and fastening of the channels in the field ensuring that the rails are cast in a coplanar manner. The trench shall not have any cross bars that will interfere with later installation of utilities in the trench. The trench shall have 1 5/8" x 1 5/8" galvanized strut channel cast into the trench walls for mounting of utilities. The strut shall have 3" x 3/8" dia. concrete anchors locking the strut into the surrounding concrete once cast. The trench body shall have the following properties: 12,600 psi minimum tensile strength per ASTM C307, 11,600 psi. minimum compressive strength per ASTM C579, 26,500 psi minimum flexural strength per ASTM C580, less than 0.35% water absorption, shall be frost proof, salt proof, and be resistant to dilute acids and alkalis per ASTM C267.

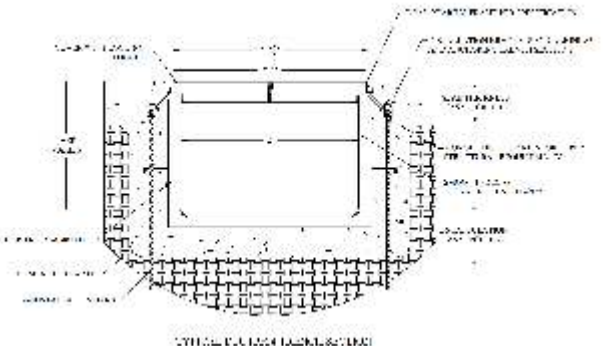

# DTUTPF36



\*shown here with the HDBP frame

## Engineering Specification:

Utility trench shall be DuraTrench as manufactured by Eric'sons, 574C Industrial Way N., Dallas, GA 30132 - (770-505-6575). The utility trench body shall act as secondary containment and be composed of polyester fiber reinforced polymer concrete. The trench shall have a 36" clear open throat and have a rectangular bottom. The trench body shall be gray in color to closely resemble the color of concrete. Sections shall be 96" long (typical) and have a 2" receiving flange on the upstream end for receiving and sealing the trench sections together. Each of the sections shall be labeled to indicate proper placement. The trench body shall mate to the frame and form a grate seat that shall accept the specified cover. The body shall be supplied with a factory fit protective top for rail alignment and fastening of the channels in the field ensuring that the rails are cast in a coplanar manner. The trench shall not have any cross bars that will interfere with later installation of utilities in the trench. The trench shall have 1 5/8" x 1 5/8" galvanized strut channel cast into the trench walls for mounting of utilities. The strut shall have 3" x 3/8" dia. concrete anchors locking the strut into the surrounding concrete once cast. The trench body shall have the following properties: 12,600 psi minimum tensile strength per ASTM C307, 11,600 psi. minimum compressive strength per ASTM C579, 26,500 psi minimum flexural strength per ASTM C580, less than 0.35% water absorption, shall be frost proof, salt proof, and be resistant to dilute acids and alkalis per ASTM C267.

## SYSTEM CHARACTERISTICS:

- Secondary containment utility trench
- Built in 1 5/8" channel strut (48" o.c. typ)
- No internal cross braces to obstruct pipe installation
- Significantly increases speed of installation
- All load classes

FRAME OPTIONS	MDGS, MDSS, MDAL, HDBP, HDGS, HDSS, HDFG, EXGS, EXSS, EXDI, CUSTOM
GRATES	38" WIDE COVERS (OPTIONAL GASKETS)
SYSTEM DEPTH	12" - 36" TYP
SECTION LENGTH	8' TYP (16' OPTION)
SLOPE	0.0%, 0.5% & 1% OR SPECIFY INVERTS

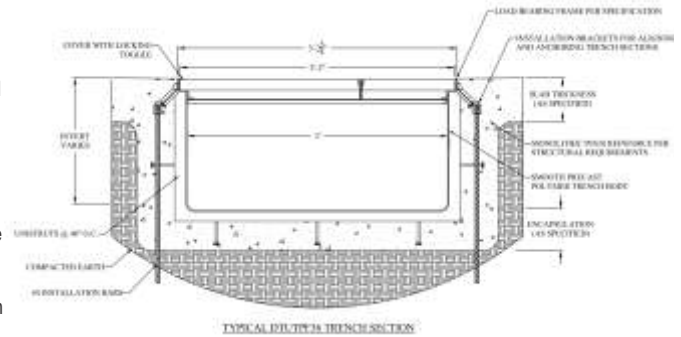

# DTUTPF48



\*shown here with the HDSS frame and 24" O.C. channel strut option

## Engineering Specification:

Utility trench shall be DuraTrench as manufactured by Eric'sons, 574C Industrial Way N., Dallas, GA 30132 - (770-505-6575). The utility trench body shall act as secondary containment and be composed of polyester fiber reinforced polymer concrete. The trench shall have a 48" clear open throat and have a rectangular bottom. The trench body shall be gray in color to closely resemble the color of concrete. Sections shall be 96" long (typical) and have a 2" receiving flange on the upstream end for receiving and sealing the trench sections together. Each of the sections shall be labeled to indicate proper placement. The trench body shall mate to the frame and form a grate seat that shall accept the specified cover. The body shall be supplied with a factory fit protective top for rail alignment and fastening of the channels in the field ensuring that the rails are cast in a coplanar manner. The trench shall not have any cross bars that will interfere with later installation of utilities in the trench. The trench shall have 1 5/8" x 1 5/8" galvanized strut channel cast into the trench walls for mounting of utilities. The strut shall have 3" x 3/8" dia. concrete anchors locking the strut into the surrounding concrete once cast. The trench body shall have the following properties: 12,600 psi minimum tensile strength per ASTM C307, 11,600 psi. minimum compressive strength per ASTM C579, 26,500 psi minimum flexural strength per ASTM C580, less than 0.35% water absorption, shall be frost proof, salt proof, and be resistant to dilute acids and alkalis per ASTM C267.

## SYSTEM CHARACTERISTICS:

- Secondary containment utility trench
- Built in 1 5/8" channel strut (48" o.c. typ)
- No internal cross braces to obstruct pipe installation
- Significantly increases speed of installation
- All load classes

FRAME OPTIONS	MDGS, MDSS, MDAL, HDBP, HDGS, HDSS, HDFG, EXGS, EXSS, EXDI, CUSTOM
GRATES	50" WIDE COVERS (OPTIONAL GASKETS)
SYSTEM DEPTH	12" - 36" TYP
SECTION LENGTH	8' TYP (16' OPTION)
SLOPE	0.0%, 0.5% & 1% OR SPECIFY INVERTS

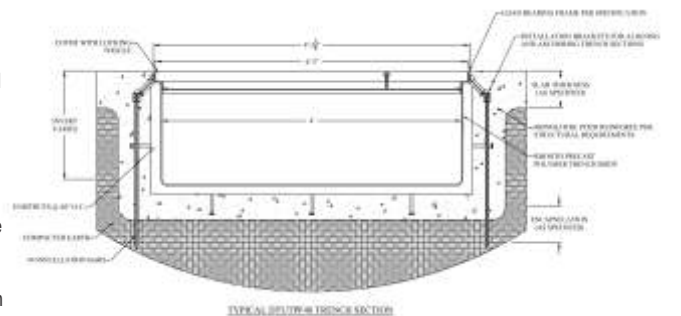





Dura Trench Utility trenches are being utilized for their flexibility of design, large sizes, ease of installation, and secondary containment properties. They can be used outdoors or indoors. The covers can have gaskets, lightweight easy to remove covers, lifting holes for large heavy duty covers, secured with vandal resistant hardware, or designed for virtually any other concern. Dura Trench Utility trenches make mounting of utilities easy with the built in channel struts and the ability to core holes at any location. Let us know how we can design a utility trench to meet your needs.





# CATCH BASINS

WIDTH	LENGTH	MIN. DEPTH	MAX. DEPTH	MAX STORAGE (GAL)
4	24	4	36	15.0
	48	4	36	29.9
8	24	4	36	29.9
	48	4	36	59.8
10	24	4	48	49.9
	48	4	48	99.7
12	24	4	48	59.8
	48	4	48	119.7
15	24	8	60	93.5
	48	8	60	187.0
18	24	8	60	112.2
	48	8	60	224.4
24	24	8	96	239.4
	30	12	96	299.2
	48	12	96	478.7
30	30	8	96	374.0
	36	12	96	448.8
	48	12	96	598.4
36	36	12	96	538.6
	48	12	96	718.1
48	48	12	96	957.4
60	60	12	96	1496.0
84	84	12	96	2932.2
96	96	12	96	3829.8

3' wide x 3' long x 4' deep chemical resistant catch basin for industrial application

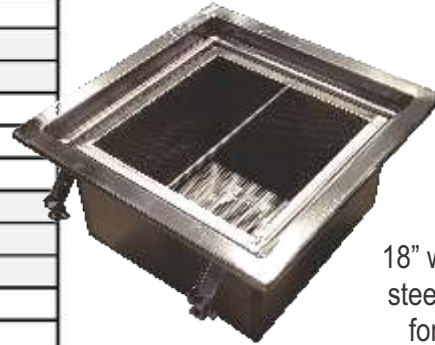

18" wide x 18" long x 12" stainless steel floor sink with debris basket for food and beverage project



1' wide x 2' long x 3' deep inline basin for vehicle maintenance bay



10" wide x 24" long x 26" deep inline basin for civil application

- CUSTOM SIZES
- ANY APPLICATION
- MOLDED RECEIVERS ACCEPT TRENCH DRAINS
- WATER TIGHT
- CHEMICAL RESISTANT
- OUTLET PIPES ANY SIZE OR LOCATION
- TRASH BUCKETS
- SEDIMENT SCREENS
- LADDERS
- SEPARATOR PLATES
- WEIR PLATES



2' wide x 2' long x 4' deep basin at service station



Large 3' wide x 12' long x 5' deep catch basins for manufacturing process application

# TRENCH FRAMES

PART NO.	MATERIAL	SEAT HEIGHT (IN)	2 SIDED BEARING AREA (SQ IN / FT)	CROSS SECTION (SQ IN)	ANCHOR SIZE	ANCHOR SPACING (IN O.C.)	CHEMICALS	H-20	FORKLIFTS	PORT DUTY
LDTP-05	GRAY PLASTIC	0.5	18	0.60	RIB	CONT.	YES	NO	NO	NO
MDGS-05	GALVANIZED STEEL	0.5	15	0.18	2" X 1/4"	24	NO	YES	NO	NO
MDSS-05	T304 STAINLESS STEEL	0.5	15	0.18	2" X 1/4"	24	YES	YES	NO	NO
MDAL-05	ALUMINUM	0.5	15	0.18	2" X 1/4"	24	NO	NO	NO	NO
LDTP-1	GRAY PLASTIC	0.75	22.5	0.80	RIB	CONT.	YES	NO	NO	NO
MDGS-1	GALVANIZED STEEL	0.75	13.5	0.19	2" X 1/4"	24	NO	YES	NO	NO
MDSS-1	T304 STAINLESS STEEL	0.75	13.5	0.19	2" X 1/4"	24	YES	YES	NO	NO
MDAL-1	ALUMINUM	0.75	15	0.54	3" X 3/8"	18	NO	YES	NO	NO
HDBP-1	BLACK POWDER PAINTED STEEL	0.75	15	0.54	3" X 3/8"	18	NO	YES	YES	NO
HDGS-1	HOT DIP GALVANIZED STEEL	0.75	15	0.54	3" X 3/8"	18	NO	YES	YES	NO
HDSS-1	T304 STAINLESS STEEL	0.75	15	0.54	3" X 3/8"	18	YES	YES	YES	NO
EXGS-1	HOT DIP GALVANIZED STEEL	0.75	39	2.05	3" X 3/8"	12	NO	YES	YES	YES
MDGS	GALVANIZED STEEL	1.5	31.5	0.22	2" X 1/4"	24	NO	YES	NO	NO
MDSS	T304 STAINLESS STEEL	1.5	31.5	0.22	2" X 1/4"	24	YES	YES	NO	NO
MDAL	ALUMINUM	1.5	31.5	0.22	2" X 1/4"	24	NO	NO	NO	NO
HDBP	BLACK POWDER PAINTED STEEL	1.5	31.5	0.75	3" X 3/8"	18	NO	YES	YES	NO
HDGS	HOT DIP GALVANIZED STEEL	1.5	31.5	0.75	3" X 3/8"	18	NO	YES	YES	NO
HDSS	T304 STAINLESS STEEL	1.5	31.5	0.85	3" X 3/8"	18	YES	YES	YES	NO
HDFG	GRAY FIBER REINFORCED PLASTIC	1.5	54	1.08	RIB	CONT.	YES	YES	YES	NO
HDAL	ALUMINUM	1.5	31.5	0.75	3" X 3/8"	18	NO	YES	NO	NO
EXBP	BLACK POWDER PAINTED STEEL	1.5	37.5	1.48	3" X 3/8"	12	NO	YES	YES	YES
EXGS	HOT DIP GALVANIZED STEEL	1.5	37.5	1.48	3" X 3/8"	12	NO	YES	YES	YES
EXDI	DUCTILE IRON	1.5	147	4.53	3" X 3/8"	18	NO	YES	YES	YES

# SLOT DRAIN FRAMES

PART NO.	MATERIAL	OPEN AREA (IN <sup>2</sup> /LF)	2 SIDED BEARING AREA (SQ IN / FT)	CROSS SECTION (SQ IN)	ANCHOR SIZE	ANCHOR SPACING (IN O.C.)	CHEMICALS	H-20	FORKLIFTS	PORT DUTY
HDSPBP-1	BLACK POWDER PAINTED STEEL	6	19.5	0.68	3" X 3/8"	24	NO	YES	YES	NO
HDSPGS-1	HOT DIP GALVANIZED STEEL	6	19.5	0.68	3" X 3/8"	24	NO	YES	YES	NO
HDSPSS-1	T304 STAINLESS STEEL	6	19.5	0.68	3" X 3/8"	24	YES	YES	YES	NO
MDSPAL	ALUMINUM	3	6	1.50	NA	NA	NO	YES	NO	NO
MDSPBP	BLACK POWDER PAINTED STEEL	3	6	1.50	NA	NA	NO	YES	NO	NO
MDSPGS	HOT DIP GALVANIZED STEEL	3	6	1.50	NA	NA	NO	YES	NO	NO
MDSPSS	T304 STAINLESS STEEL	3	6	1.50	NA	NA	YES	YES	NO	NO
HDSPBP	BLACK POWDER PAINTED STEEL	6.75	36	1.52	3" X 3/8"	18	NO	YES	YES	NO
HDSPGS	ZINC PLATED STEEL	6.75	36	1.52	3" X 3/8"	18	NO	YES	YES	NO
HDSPSS	T304 STAINLESS STEEL	6.75	36	1.52	3" X 3/8"	18	YES	YES	YES	NO
EXSPBP	BLACK POWDER PAINTED STEEL	20.34	36	1.52	3" X 3/8"	18	NO	YES	YES	YES
EXSPGS	HOT DIP GALVANIZED STEEL	20.34	36	1.52	3" X 3/8"	18	NO	YES	YES	YES
EXSPSS	T304 STAINLESS STEEL	20.34	36	1.52	3" X 3/8"	18	YES	YES	YES	YES

# TRASH & DEBRIS STRAINERS

Trash and debris often need to be screened out of the effluent traveling in a linear drain. The Dura Trench line offers trash baskets, outlet strainers, and sediment buckets. For large or floating particulate a trash basket or outlet strainer can be used. The hole size can be varied to match the size of the particulate. Typical hole sizes are 0.25" or 0.125" holes. In some cases the particulate is heavy solids and falls to the bottom. For these cases a solid sediment bucket works best. No matter the particulate we can provide adequate separation of the liquid and solid matter to keep your drains flowing.



# URNS & INTERSECTIONS

Factory built turns, intersections, and unique fabrications are important advantages of the Dura-Trench line. These shop made fabrications ensure a high quality connection and a good fit. Prefabricated parts save significant time in the field making the Dura-Trench system the easiest product on the market to install.

Simply show the plan view of the trench layout and we will fabricate to match your every need. True custom trench drain design is 100% achievable without compromise to the project design.

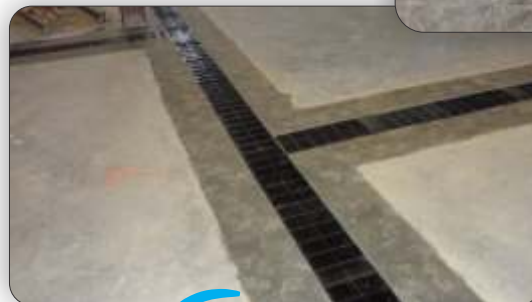

# GRATE LOCKS

Grates can be locked to the trench frame by using either a locking bar or bolts through the corners of the grates. Note that in many applications the grates locking mechanisms are not necessary due to the weight of the grate material and type of traffic.





# OUTLETS / INLETS

Outlet pipes for the Dura-Trench system are made easy for the installer and water tight for the designer. When possible, the outlet connections are fabricated into the trench body at the factory. This ensures that the pipes are sealed to the trench and never loose or flimsy. The outlet pipes can be attached to the end of the trench, anywhere along the side of the trench, or anywhere along the bottom of the trench. Inlet pipes from down spouts or other trenches can also be located anywhere along the length of the run, simply specify pipe size, location, and invert.

The pipe connections can be any size from 1" up to 24". Any size outlet can be supplied on any size trench. Schedule 40 or SDR35 PVC pipe connections are typically supplied, however, HDPE, Stainless steel, Ductile iron, or other pipe materials are available upon request. Field fit universal end plates are also available for off the shelf applications.



**SIDE OUTLET**



**END OUTLET**



**UNIVERSAL OUTLETS  
END, BOTTOM,  
OR SIDE OUTLET**



**BOTTOM OUTLET**

# JOINT SEALANT

Sealant can be an integral part of any trench drain system. For storm water applications, no sealant is typically required. If sealant is preferred for simple water or dilute chemicals, a single component urethane caulk (SLUR) is recommended.

For applications where a more durable seal is required our two part pastes can be used to seal the joints. Before applying these types of sealants, the joints need to be lightly sanded and cleaned. This will ensure a full bond of the two parts. The paste kits come with reinforcing fiber mixed into the paste and are very strong. Polyester (SLPF) and vinyl ester (SLCF) kits are offered. For water tight sealing or light chemical exposure the polyester is often sufficient. For severe chemical attack and longer term exposures the vinyl ester is more desirable.

When using a metal trench body, the best seal you can achieve is to fully weld any seams or joints.



# GRATES

\*NOTE: NOT ALL GRATES ARE DEPICTED IN ALL FINISHES OFFERED, HOWEVER PATTERN REMAINS SAME FOR ALL FINISHES

## 3" WIDE GRATES



PART #	DESCRIPTION	DIN LOAD
03C24DI	HEEL PROOF DUCTILE IRON GRATE	E
03CF24BP	HEEL PROOF BLACK POWDER COATED STEEL GRATE	B/D
03CF24GS	HEEL PROOF GALVANIZED STEEL GRATE	B/D
03CF24SS	HEEL PROOF STAINLESS STEEL GRATE	B/D
03C24TP	HEEL PROOF THERMOPLASTIC GRATE	B
03E24GS	PERFORATED HEEL PROOF GALV. STEEL GRATE	B
03E24SS	PERFORATED HEEL PROOF STAINLESS GRATE	B
03M24SS	HEEL PROOF MESH STAINLESS GRATE	B
03BW48SSA	BASKET WEAVE STAINLESS DECORATIVE GRATE	A
03CS48SSA	LINEAR STAGGERED SLOT DECORATIVE GRATE	A
03F48SSA	DIAGONAL SLOT DECORATIVE GRATE	A
03BW48SSA	SLOTTED WAVE DECORATIVE GRATE	A

## 5" WIDE GRATES



PART #	DESCRIPTION	DIN LOAD
05A24BP	BLACK POWDER PAINTED STEEL SOLID COVER	E
05A24GS	GALVANIZED STEEL SOLID COVER	E
05A24SS	STAINLESS STEEL SOLID COVER	E
05B24DI	DUCTILE IRON SLOTTED GRATE	E
05B24DG	GALVANIZED IRON SLOTTED GRATE	E
05B24SSC	STAINLESS SLOTTED GRATE	C
05B24SSE	STAINLESS SLOTTED GRATE	E
05B24DIF	DUCTILE IRON SLOTTED GRATE	F
05BF24BP	BLACK POWDER PAINTED STEEL SLOTTED GRATE	D
05BF24GS	GALVANIZED STEEL SLOTTED GRATE	D
05BF24SS	STAINLESS STEEL SLOTTED GRATE	D
05C24DI	DUCTILE IRON ADA/HEEL PROOF GRATE	D
05C24DG	GALVANIZED IRON ADA/HEEL PROOF GRATE	D



# 5" WIDE GRATES

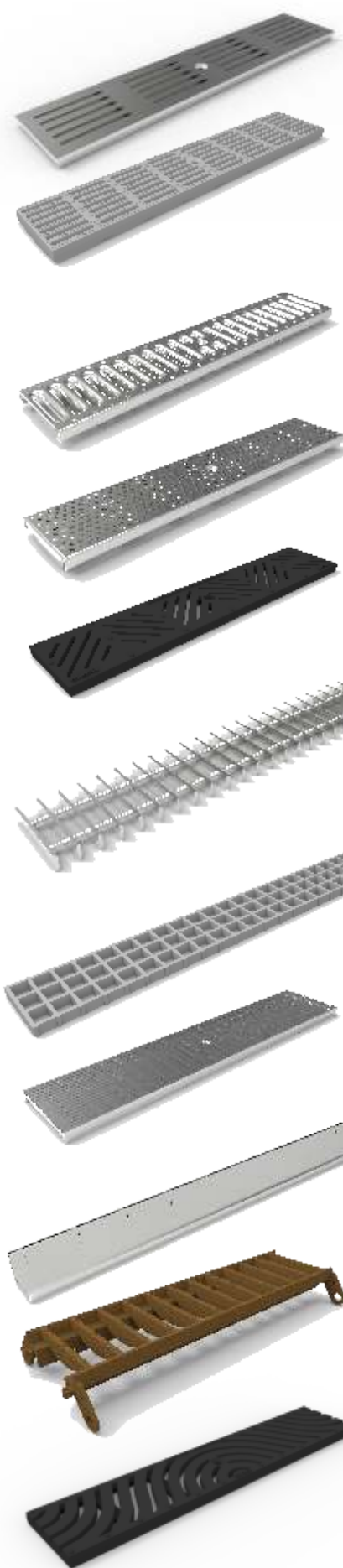

PART #	DESCRIPTION	DIN LOAD
05CF24BP	BLACK POWDER PAINTED ADA/HEEL PROOF GRATE	E
05CF24GS	GALVANIZED STEEL ADA/HEEL PROOF GRATE	E
05CF24SS	STAINLESS STEEL ADA/HEEL PROOF GRATE	E
05C24TP	PLASTIC ADA/HEEL PROOF GRATE	A
05D24GSB	GALVANIZED STAMPED STEEL SLOTTED GRATE	B
05D24GSC	GALVANIZED REINFORCED STEEL SLOTTED GRATE	C
05D24SSB	STAINLESS STAMPED STEEL SLOTTED GRATE	B
05D24SSC	STAINLESS REINFORCED STEEL SLOTTED GRATE	C
05E24GSA	GALVANIZED HEEL PROOF PERFORATED GRATE	A
05E24GSC	GALVANIZED HEEL PROOF PERFORATED GRATE	C
05E24SSA	STAINLESS HEEL PROOF PERFORATED GRATE	A
05E24SSC	STAINLESS HEEL PROOF PERFORATED GRATE	C
05F24DI	DUCTILE IRON DIAGONAL SLOTTED ADA GRATE	D
05F24DG	GALVANIZED IRON DIAGONAL SLOTTED ADA GRATE	D
05F24SS	STAINLESS STEEL DIAGONAL SLOTTED ADA GRATE	D
05G36GSC	GALVANIZED STEEL BAR GRATE	B
05G36SSC	STAINLESS STEEL BAR GRATE	B
05H48FG	FIBERGLASS MESH GRATE	B
05M24SS	STAINLESS STEEL HEEL PROOF MESH GRATE	B
05PS24GS	GALVANIZED STEEL HEEL PROOF PAVER SLOT	C
05PS24SS	STAINLESS STEEL HEEL PROOF PAVER SLOT	C
05T24DI	DUCTILE IRON HIGH FLOW SLOTTED GRATE	D
05W24DI	DUCTILE IRON WAVE PATTERN GRATE	C
05W24DG	GALVANIZED IRON WAVE PATTERN GRATE	C

# 8" WIDE GRATES

	PART #	DESCRIPTION	DIN LOAD
	08A24BP	BLACK POWDER COATED SOLID COVER	D
	08A24GS	GALVANIZED STEEL SOLID COVER	D
	08A24SS	STAINLESS STEEL SOLID COVER	D
	08B24CI	CAST IRON SLOTTED GRATE	D
	08B24DI	DUCTILE IRON SLOTTED GRATE	E
	08B24DG	GALVANIZED IRON SLOTTED GRATE	E
	08BF24BP	BLACK POWDER COATED STEEL SLOTTED GRATE	E
	08BF24GS	GALVANIZED STEEL SLOTTED GRATE	E
	08BF24SS	STAINLESS STEEL SLOTTED GRATE	E
	08C24CI	CAST IRON ADA/HEEL PROOF SLOTTED GRATE	D
	08B24DI	DUCTILE IRON ADA/HEEL PROOF SLOTTED GRATE	E
	08B24DG	GALVANIZED IRON ADA/HEEL PROOF SLOTTED GRATE	E
	08CF24BP	BLACK ADA/HEEL PROOF STEEL GRATE	E
	08CF24GS	GALVANIZED ADA/HEEL PROOF STEEL GRATE	E
	08CF24SS	STAINLESS ADA/HEEL PROOF GRATE	E
	08E24GS	GALVANIZED STEEL HEEL PROOF PERFORATED GRATE	D
	08E24SS	STAINLESS STEEL HEEL PROOF PERFORATED GRATE	D
	08G36GSC	GALVANIZED STEEL BAR GRATE	C
	08G36GSD	GALVANIZED STEEL BAR GRATE	D
	08G36GSE	GALVANIZED STEEL BAR GRATE	E
	08G36SSC	STAINLESS STEEL BAR GRATE	C
	08G36SSD	STAINLESS STEEL BAR GRATE	D
	08G36SSE	STAINLESS STEEL BAR GRATE	E
	08G48FG	PULTRUDED FIBERGLASS BAR GRATE	D



## 8" WIDE GRATES

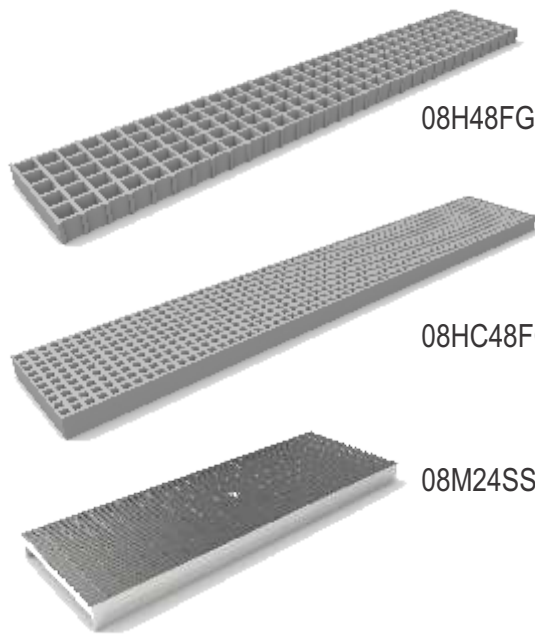



PART #	DESCRIPTION	DIN LOAD
08H48FG	FIBERGLASS MESH GRATE	C
08HC48FG	FIBERGLASS ADA MESH GRATE	C
08M24SS	STAINLESS HEEL PROOF MESH GRATE	B

## 10" WIDE GRATES

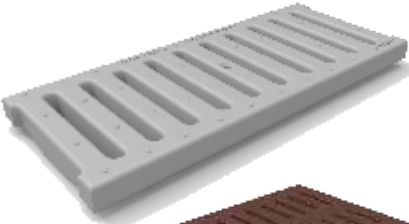
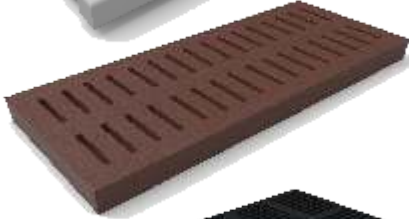

PART #	DESCRIPTION	DIN LOAD
10A24BP	BLACK POWDER PAINTED STEEL SOLID COVER	D
10A24GS	GALVANIZED STEEL SOLID COVER	D
10A24SS	STAINLESS STEEL SOLID COVER	D
10B24CI	CAST IRON SLOTTED GRATE	C
10B24DI	DUCTILE IRON SLOTTED GRATE	E
10B24DG	GALVANIZED IRON SLOTTED GRATE	E
10B24DIF	DUCTILE IRON SLOTTED GRATE	F
10B24DGF	GALVANIZED IRON SLOTTED GRATE	F
10BF24BP	BLACK POWDER PAINTED STEEL SLOTTED GRATE	E
10BF24GS	GALVANIZED STEEL SLOTTED GRATE	E
10BF24SS	STAINLESS STEEL SLOTTED GRATE	E

# 10" WIDE GRATES

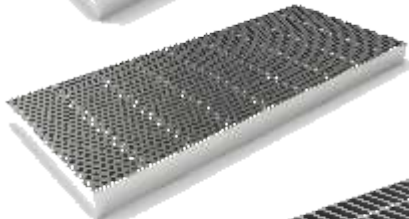
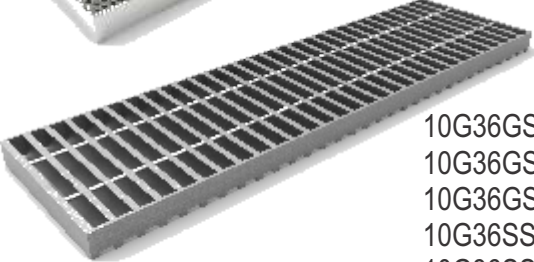
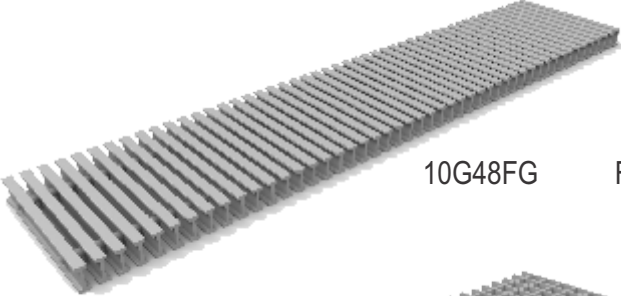
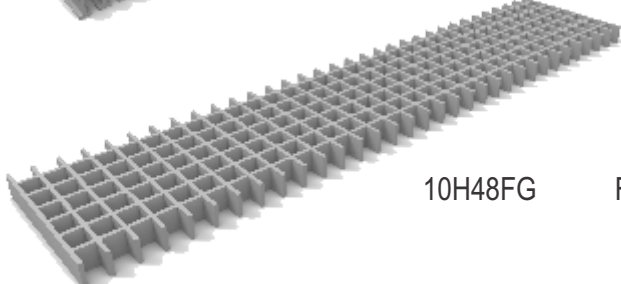
	PART #	DESCRIPTION	DIN LOAD
	10B24FG	SLOTTED COMPOSITE GRATE	D
	10C24CI	CAST IRON ADA/HEEL PROOF SLOTTED GRATE	C
	10C24DI	DUCTILE IRON ADA/HEEL PROOF SLOTTED GRATE	D
	10C24DG	GALVANIZED IRON ADA/HEEL PROOF SLOTTED GRATE	D
	10CF24BP	BLACK ADA/HEEL PROOF STEEL SLOTTED GRATE	D
	10CF24GS	GALVANIZED ADA/HEEL PROOF STEEL SLOTTED GRATE	D
	10CF24SS	STAINLESS ADA/HEEL PROOF SLOTTED GRATE	D
	10E24GS	GALVANIZED STEEL HEEL PROOF PERFORATED GRATE	C
	10E24SS	STAINLESS STEEL HEEL PROOF PERFORATED GRATE	C
	10G36GSC	GALVANIZED STEEL BAR GRATE	C
	10G36GSD	GALVANIZED STEEL BAR GRATE	D
	10G36GSE	GALVANIZED STEEL BAR GRATE	E
	10G36SSC	STAINLESS STEEL BAR GRATE	C
	10G36SSD	STAINLESS STEEL BAR GRATE	D
	10G36SSE	STAINLESS STEEL BAR GRATE	E
	10G48FG	FIBERGLASS BAR GRATE	D
	10H48FG	FIBERGLASS MESH GRATE	B



## 10" WIDE GRATES

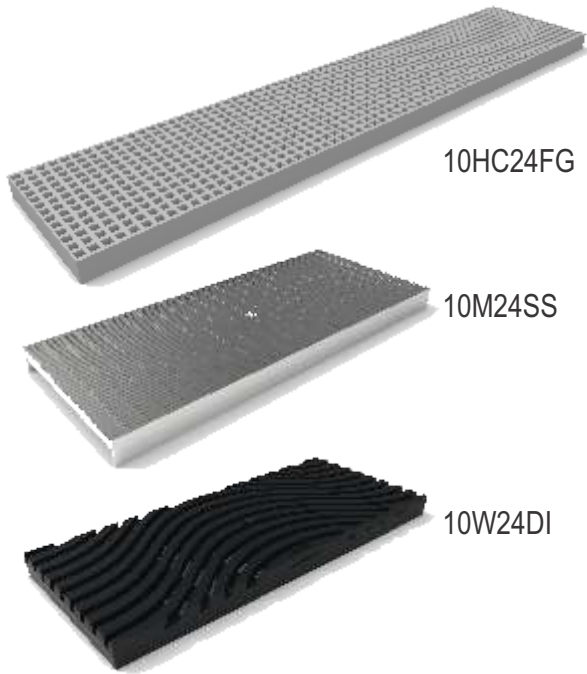

PART #	DESCRIPTION	DIN LOAD
10HC24FG	FIBERGLASS ADA MESH GRATE	B
10M24SS	STAINLESS STEEL MESH GRATE	B
10W24DI	DUCTILE IRON ADA WAVE GRATE	D

## 12" WIDE GRATES



PART #	DESCRIPTION	DIN LOAD
12A24BP	BLACK POWDER PAINTED STEEL SOLID COVER	E
12A24GS	GALVANIZED STEEL SOLID COVER	E
12A24SS	STAINLESS STEEL SOLID COVER	E
12B24CI	CAST IRON SLOTTED GRATE	D
12B24DI	DUCTILE IRON SLOTTED GRATE	E
12B24DG	GALVANIZED IRON SLOTTED GRATE	E
12B24DIF	DUCTILE IRON SLOTTED GRATE	F

# 12" WIDE GRATES

PART #	DESCRIPTION	DIN LOAD
12BF24BP	BLACK POWDER COATED STEEL SLOTTED GRATE	D
12BF24GS	GALVANIZED STEEL SLOTTED GRATE	D
12BF24SS	STAINLESS STEEL SLOTTED GRATE	D
12B24FG	SLOTTED COMPOSITE GRATE	D
12C24CI	CAST IRON ADA/HEEL PROOF SLOTTED GRATE	C
12C24DI	DUCTILE IRON ADA/HEEL PROOF SLOTTED GRATE	D
12C24DG	GALVANIZED IRON ADA/HEEL PROOF SLOTTED GRATE	D
12CF24BP	BLACK ADA/HEEL PROOF STEEL SLOTTED GRATE	D
12CF24GS	GALVANIZED ADA/HEEL PROOF STEEL SLOTTED GRATE	D
12CF24SS	STAINLESS ADA/HEEL PROOF SLOTTED GRATE	D
12E24GS	GALVANIZED STEEL HEEL PROOF PERFORATED GRATE	D
12E24SS	STAINLESS STEEL HEEL PROOF PERFORATED GRATE	D
12F24DI	DUCTILE IRON ADA DIAGONAL SLOTTED GRATE	D
12G36GSC	GALVANIZED STEEL BAR GRATE	C
12G36GSD	GALVANIZED STEEL BAR GRATE	D
12G36GSE	GALVANIZED STEEL BAR GRATE	E
12G36SSC	STAINLESS STEEL BAR GRATE	C
12G36SSD	STAINLESS STEEL BAR GRATE	D
12G36SSE	STAINLESS STEEL BAR GRATE	E

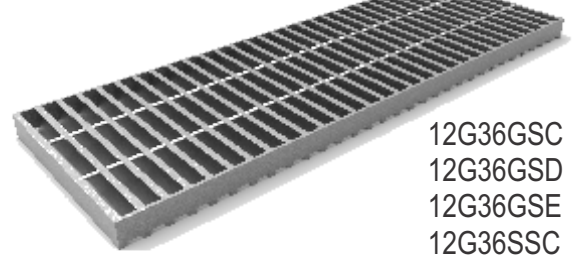
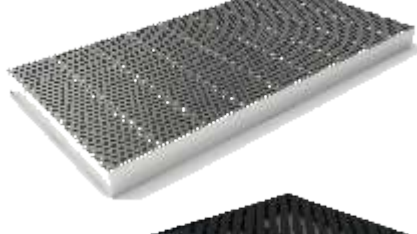

## 12" WIDE GRATES

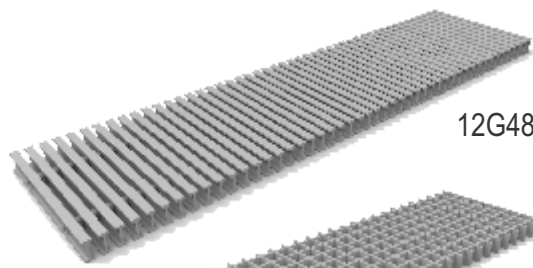

PART #

DESCRIPTION

DIN  
LOAD

12G48FG

FIBERGLASS BAR GRATE

D

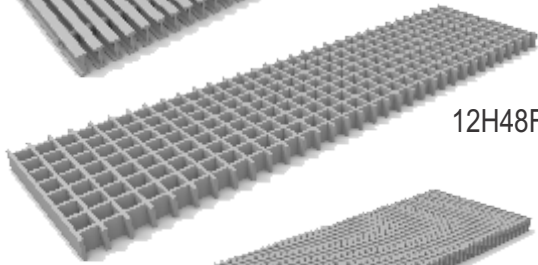

12H48FG

FIBERGLASS MESH GRATE

B

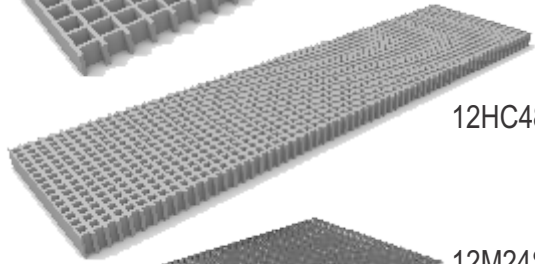

12HC48FG

FIBERGLASS ADA MESH GRATE

B



12M24SS

STAINLESS ADA/HEEL PROOF MESH GRATE

A

## 14" WIDE GRATES



PART #

DESCRIPTION

DIN  
LOAD

14A24BP

BLACK POWDER PAINTED STEEL SOLID COVER

D

14A24GS

GALVANIZED STEEL SOLID COVER

D

14A24SS

STAINLESS STEEL SOLID COVER

D



14B24CI

CAST IRON SLOTTED GRATE

C



14B24DI

DUCTILE IRON SLOTTED GRATE

D

14B24DG

GALVANIZED IRON SLOTTED GRATE

D

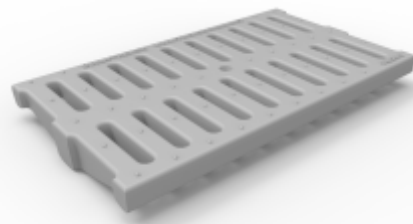

14B24FG

SLOTTED COMPOSITE GRATE

D



# 14" WIDE GRATES

PART #	DESCRIPTION	DIN LOAD
14B24DIF	DUCTILE IRON SLOTTED GRATE	F
14B24DGF	GALVANIZED IRON SLOTTED GRATE	F
14BF24BP	BLACK COATED STEEL SLOTTED GRATE	D
14BF24GS	GALVANIZED STEEL SLOTTED GRATE	D
14BF24SS	STAINLESS STEEL SLOTTED GRATE	D
14C24CI	CAST IRON ADA/HEEL PROOF SLOTTED GRATE	C
14C24DI	DUCTILE IRON ADA/HEEL PROOF SLOTTED GRATE	D
14C24DG	GALVANIZED IRON ADA/HEEL PROOF SLOTTED GRATE	D
14CF24BP	BLACK COATED STEEL ADA/HEEL PROOF SLOTTED GRATE	D
14CF24GS	GALVANIZED STEEL ADA/HEEL PROOF SLOTTED GRATE	D
14CF24SS	STAINLESS STEEL ADA/HEEL PROOF SLOTTED GRATE	D
14E24GS	GALVANIZED STEEL HEEL PROOF PERFORATED GRATE	D
14E24SS	STAINLESS STEEL HEEL PROOF PERFORATED GRATE	D
14G36GSC	GALVANIZED STEEL BAR GRATE	C
14G36GSD	GALVANIZED STEEL BAR GRATE	D
14G36GSE	GALVANIZED STEEL BAR GRATE	E
14G36SSC	STAINLESS STEEL BAR GRATE	C
14G36SSD	STAINLESS STEEL BAR GRATE	D
14G36SSE	STAINLESS STEEL BAR GRATE	E
14G48FG	FIBERGLASS BAR GRATE	C

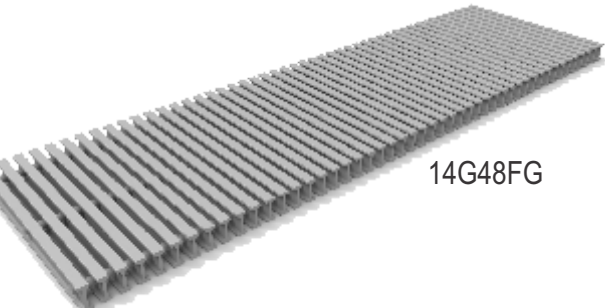
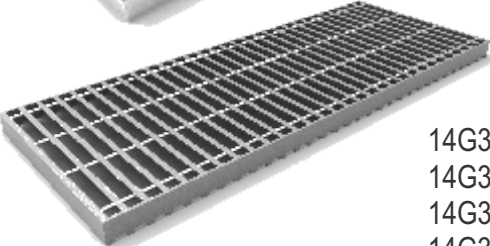
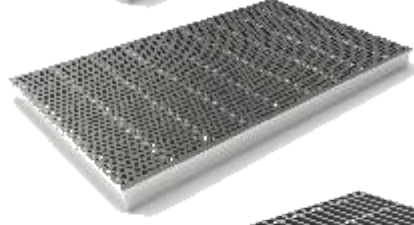
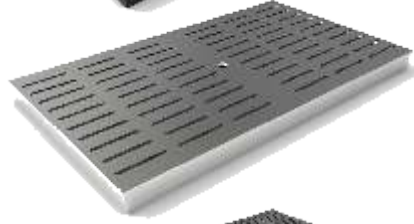

## 14" WIDE GRATES

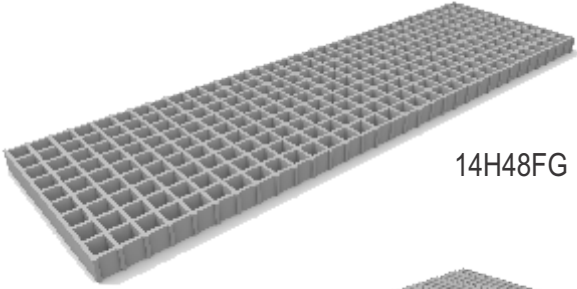
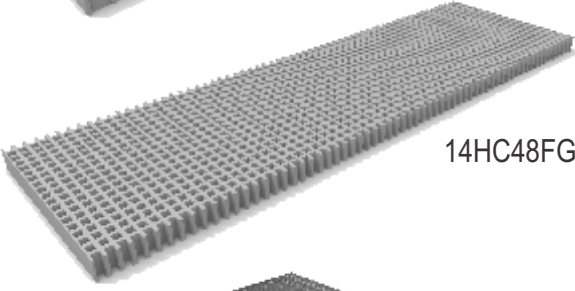
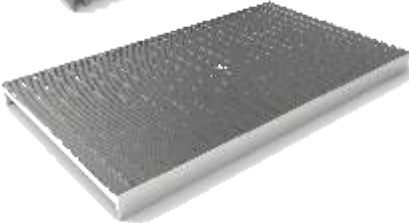
	PART #	DESCRIPTION	DIN LOAD
	14H48FG	FIBERGLASS MESH GRATE	B
	14HC48FG	FIBERGLASS ADA MESH GRATE	B
	14M24SS	STAINLESS STEEL ADA/HEEL PROOF MESH GRATE	A

## 20" WIDE GRATES

	PART #	DESCRIPTION	DIN LOAD
	20A24BP	BLACK POWDER PAINTED STEEL SOLID COVER	D
	20A24GS	GALVANIZED STEEL SOLID COVER	D
	20A24SS	STAINLESS STEEL SOLID COVER	D
	20B24CI	CAST IRON SLOTTED GRATE	C
	20B24DI	DUCTILE IRON SLOTTED GRATE	D
	20B24DG	GALVANIZED IRON SLOTTED GRATE	D
	20B24DIF	DUCTILE IRON SLOTTED GRATE	F
	20B24DGF	GALVANIZED IRON SLOTTED GRATE	F

# 20" WIDE GRATES

PART #	DESCRIPTION	DIN LOAD
--------	-------------	----------



20BF24BP	BLACK COATED STEEL SLOTTED GRATE	D
20BF24GS	GALVANIZED STEEL SLOTTED GRATE	D
20BF24SS	STAINLESS STEEL SLOTTED GRATE	D

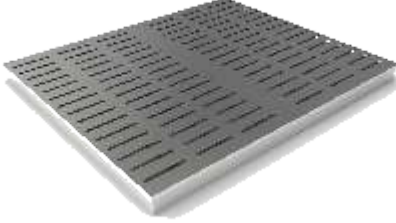

20CF24BP	BLACK COATED STEEL ADA/HEEL PROOF SLOTTED GRATE	C
20CF24GS	GALVANIZED STEEL ADA/HEEL PROOF SLOTTED GRATE	C
20CF24SS	STAINLESS STEEL ADA/HEEL PROOF SLOTTED GRATE	C



20E24GS	GALVANIZED STEEL HEEL PROOF PERFORATED GRATE	C
20E24SS	STAINLESS STEEL HEEL PROOF PERFORATED GRATE	C

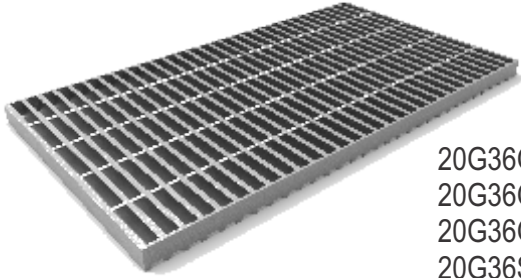

20G36GSB	GALVANIZED STEEL BAR GRATE	B
20G36GSC	GALVANIZED STEEL BAR GRATE	C
20G36GSD	GALVANIZED STEEL BAR GRATE	D
20G36SSB	STAINLESS STEEL BAR GRATE	B
20G36SSC	STAINLESS STEEL BAR GRATE	C
20G36SSD	STAINLESS STEEL BAR GRATE	D

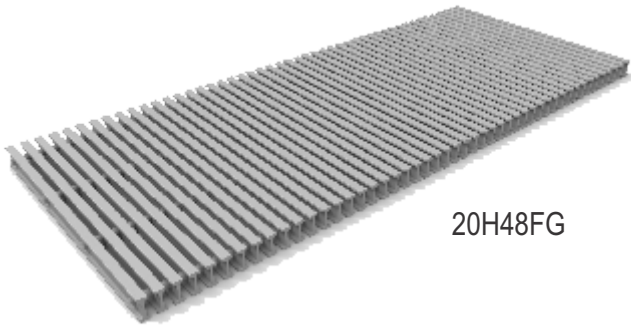

20H48FG	FIBERGLASS BAR GRATE	C
---------	----------------------	---

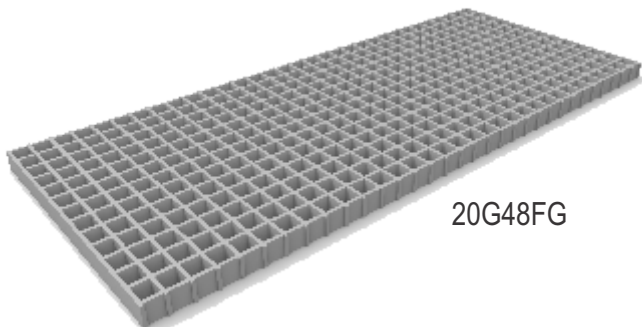

20G48FG	FIBERGLASS MESH GRATE	A
---------	-----------------------	---



## 20" WIDE GRATES

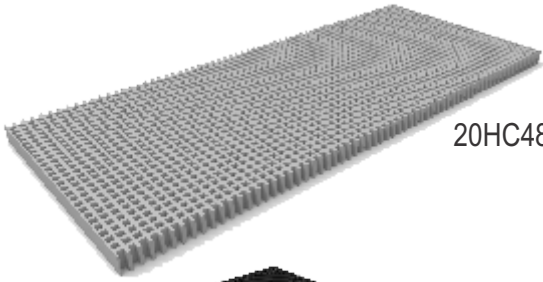

PART #

DESCRIPTION

DIN  
LOAD

20HC48FG

FIBERGLASS ADA MESH GRATE

A



20W24DI

DUCTILE IRON WAVE GRATE

C

## 26" WIDE GRATES



PART #

DESCRIPTION

DIN  
LOAD

26A24BP  
26A24GS  
26A24SS

BLACK POWDER PAINTED STEEL SOLID COVER  
GALVANIZED STEEL SOLID COVER  
STAINLESS STEEL SOLID COVER

D  
D  
D



26A24DI

DUCTILE IRON SOLID COVER

D



26B24CI

CAST IRON SLOTTED GRATE

C



26B24DI  
26B24DG

DUCTILE IRON SLOTTED GRATE  
GALVANIZED IRON SLOTTED GRATE

D  
D

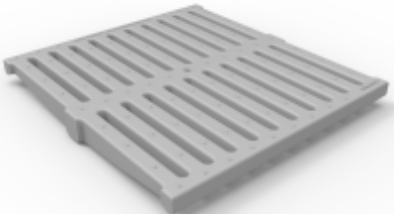

26B24FG

SLOTTED COMPOSITE GRATE

D





26B24DIF  
26B24DGF

DUCTILE IRON SLOTTED GRATE  
GALVANIZED IRON SLOTTED GRATE

F  
F

## 26" WIDE GRATES

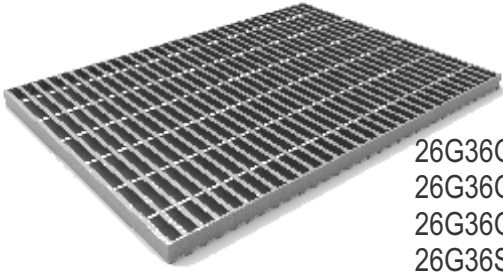
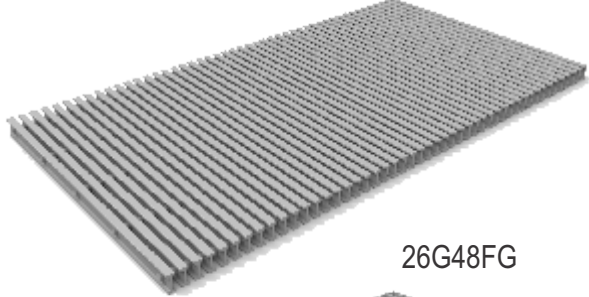
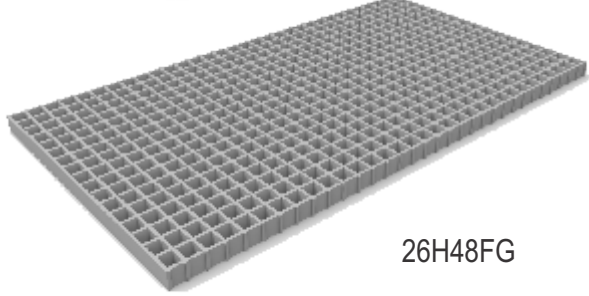
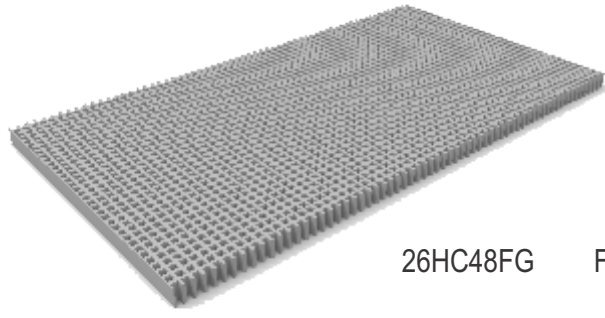
	PART #	DESCRIPTION	DIN LOAD
	26BF24BPB	BLACK COATED STEEL SLOTTED GRATE	B
	26BF24BPD	BLACK COATED STEEL SLOTTED GRATE	D
	26BF24GSB	GALVANIZED STEEL SLOTTED GRATE	B
	26BF24GSD	GALVANIZED STEEL SLOTTED GRATE	D
	26BF24SSB	STAINLESS STEEL SLOTTED GRATE	B
	26BF24SSD	STAINLESS STEEL SLOTTED GRATE	D
	26CF24BPB	BLACK COATED STEEL ADA/HEEL PROOF SLOTTED GRATE	B
	26CF24BPC	BLACK COATED STEEL ADA/HEEL PROOF SLOTTED GRATE	C
	26CF24GSB	GALVANIZED STEEL ADA/HEEL PROOF SLOTTED GRATE	B
	26CF24GSC	GALVANIZED STEEL ADA/HEEL PROOF SLOTTED GRATE	C
	26CF24SSB	STAINLESS STEEL ADA/HEEL PROOF SLOTTED GRATE	B
	26CF24SSC	STAINLESS STEEL ADA/HEEL PROOF SLOTTED GRATE	C
	26G36GSA	GALVANIZED STEEL BAR GRATE	A
	26G36GSB	GALVANIZED STEEL BAR GRATE	B
	26G36GSC	GALVANIZED STEEL BAR GRATE	C
	26G36SSA	STAINLESS STEEL BAR GRATE	A
	26G36SSB	STAINLESS STEEL BAR GRATE	B
	26G36SSC	STAINLESS STEEL BAR GRATE	C
	26G48FG	FIBERGLASS BAR GRATE	B
	26H48FG	FIBERGLASS MESH GRATE	A
	26HC48FG	FIBERGLASS ADA MESH GRATE	A

# 38" WIDE GRATES

	PART #	DESCRIPTION	DIN LOAD
	38A24BP	BLACK POWDER PAINTED STEEL SOLID COVER	D
	38A24GS	GALVANIZED STEEL SOLID COVER	D
	38A24SS	STAINLESS STEEL SOLID COVER	D
	38A24DI	DUCTILE IRON SOLID COVER	C
	38B38CI	CAST IRON SLOTTED GRATE	B
	38BF24BPB	BLACK COATED STEEL SLOTTED GRATE	B
	38BF24BPD	BLACK COATED STEEL SLOTTED GRATE	D
	38BF24GSB	GALVANIZED STEEL SLOTTED GRATE	B
	38BF24GSD	GALVANIZED STEEL SLOTTED GRATE	D
	38BF24SSB	STAINLESS STEEL SLOTTED GRATE	B
	38BF24SSD	STAINLESS STEEL SLOTTED GRATE	D
	38CF24BPB	BLACK COATED STEEL ADA/HEEL PROOF SLOTTED GRATE	B
	38CF24BPD	BLACK COATED STEEL ADA/HEEL PROOF SLOTTED GRATE	D
	38CF24GSB	GALVANIZED STEEL ADA/HEEL PROOF SLOTTED GRATE	B
	38CF24GSD	GALVANIZED STEEL ADA/HEEL PROOF SLOTTED GRATE	D
	38CF24SSB	STAINLESS STEEL ADA/HEEL PROOF SLOTTED GRATE	B
	38CF24SSD	STAINLESS STEEL ADA/HEEL PROOF SLOTTED GRATE	D
	38G36GSA	GALVANIZED STEEL BAR GRATE	A
	38G36GSB	GALVANIZED STEEL BAR GRATE	B
	38G36GSC	GALVANIZED STEEL BAR GRATE	C
	38G36SSA	STAINLESS STEEL BAR GRATE	A
	38G36SSB	STAINLESS STEEL BAR GRATE	B
	38G36SSC	STAINLESS STEEL BAR GRATE	C



## 38" WIDE GRATES

PART #	DESCRIPTION	DIN LOAD
--------	-------------	----------

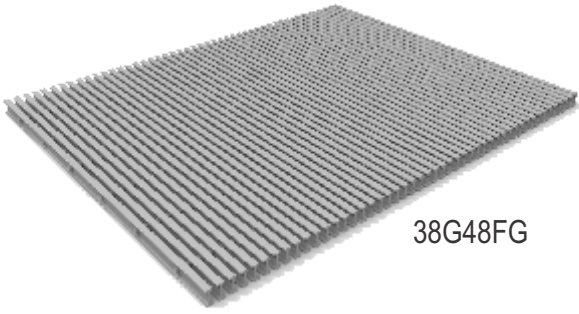

38G48FG	FIBERGLASS BAR GRATE	B
---------	----------------------	---

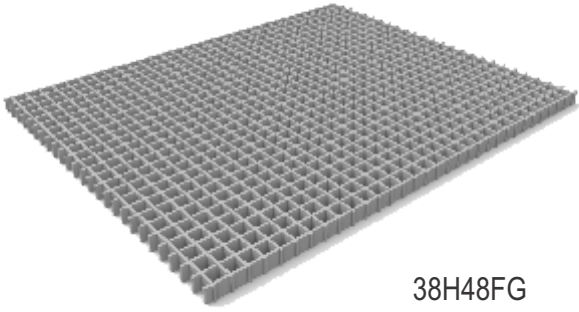

38H48FG	FIBERGLASS MESH GRATE	A
---------	-----------------------	---

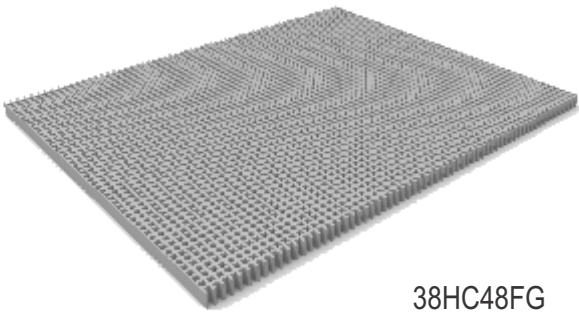

38HC48FG	FIBERGLASS ADA MESH GRATE	A
----------	---------------------------	---

## 50" WIDE GRATES

PART #	DESCRIPTION	DIN LOAD
--------	-------------	----------



50A24DI	DUCTILE IRON SOLID COVER	C
---------	--------------------------	---



50BF24BPB	BLACK COATED STEEL SLOTTED GRATE	B
50BF24BPD	BLACK COATED STEEL SLOTTED GRATE	D
50BF24GSB	GALVANIZED STEEL SLOTTED GRATE	B
50BF24GSD	GALVANIZED STEEL SLOTTED GRATE	D
50BF24SSB	STAINLESS STEEL SLOTTED GRATE	B
50BF24SSD	STAINLESS STEEL SLOTTED GRATE	D

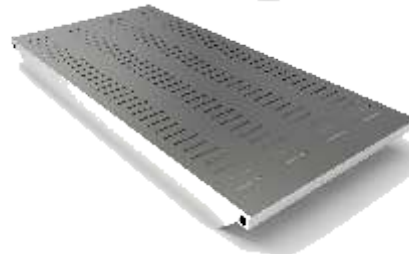

50CF24BPB	BLACK COATED STEEL ADA/HEEL PROOF SLOTTED GRATE	B
50CF24BPD	BLACK COATED STEEL ADA/HEEL PROOF SLOTTED GRATE	D
50CF24GSB	GALVANIZED STEEL ADA/HEEL PROOF SLOTTED GRATE	B
50CF24GSD	GALVANIZED STEEL ADA/HEEL PROOF SLOTTED GRATE	D
50CF24SSB	STAINLESS STEEL ADA/HEEL PROOF SLOTTED GRATE	B
50CF24SSD	STAINLESS STEEL ADA/HEEL PROOF SLOTTED GRATE	D

# 50" WIDE GRATES

PART #

DESCRIPTION

DIN  
LOAD

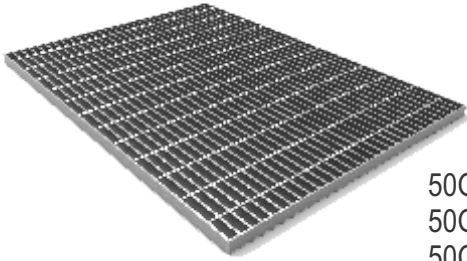

50G36GSA  
50G36GSB  
50G36SSA  
50G36SSB

GALVANIZED STEEL BAR GRATE  
GALVANIZED STEEL BAR GRATE  
STAINLESS STEEL BAR GRATE  
STAINLESS STEEL BAR GRATE

A  
B  
A  
B

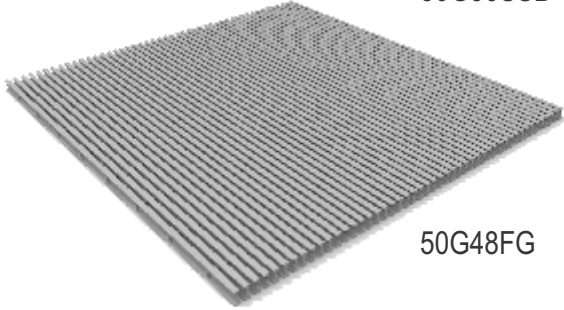

50G48FG

FIBERGLASS BAR GRATE

A

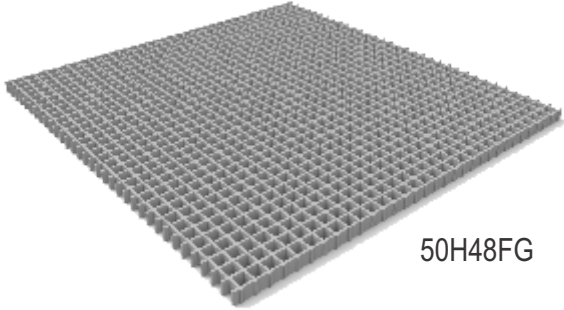

50H48FG

FIBERGLASS MESH GRATE

A

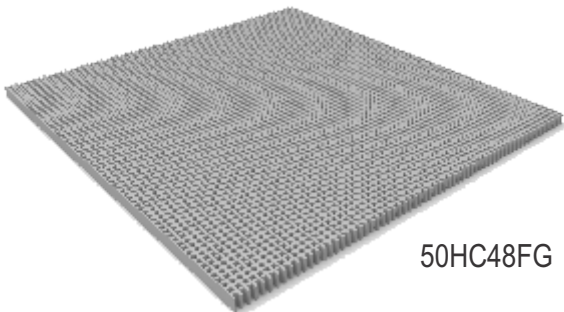

50HC48FG

FIBERGLASS ADA MESH GRATE

A

## CUSTOM GRATES

In addition to the standard style grates in this section, Dura-Trench offers custom grate design. Openings can be holes, slots, logo designs, etc. Grate material can range from stone, brass, stainless, aluminum, steel, composites, to plastics. Finishes can include special colors, anodizing, textures, etc. Please contact us for additional information regarding specific needs.



Solid cover to accept VCT tile

Plastic aeration grate

Radius stone grate

# **Dura Trench** manufactured by Eric'sons

Corporate / Southeast Office  
574 Industrial Way N.  
Dallas, GA 30132

Northeast Office  
13300 Ramblewood Dr.  
Chester, VA 23586

West Coast Office  
1701 40th St.  
Sacramento, CA 95819

***www.trenchdrain.net***  
***770-505-6575***



***SCHOOLS***



***MILITARY***



**PROUDLY MADE  
IN THE U.S.A.**

All reasonable care has been used in preparation of this information. Eric'sons core values are to promote continual improvement of our products. As such, all products and specifications are subject to change without notice. The recommendations on use of the products cannot be guaranteed as the conditions of use are beyond the control of the manufacturer. The customer has the responsibility of ensuring that the products selected are suitable for the actual application.

**REV8**